

# EXTREMITIES

Operative Technique

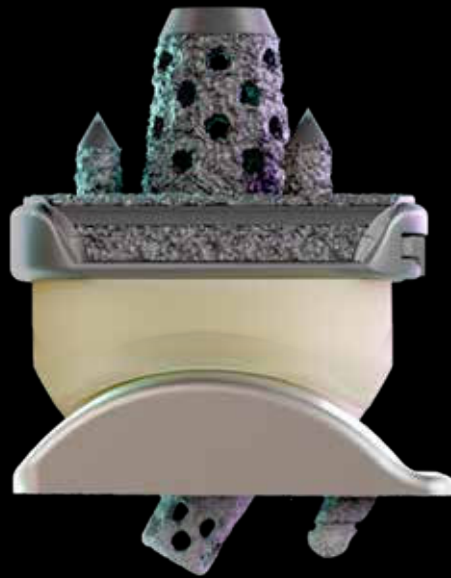

**VANTAGE**<sup>®</sup>  
TOTAL ANKLE

**Vantage Total Ankle System Operative Technique  
with the Vantage Ankle 3D+ Tibia and Flat Cut Talus**



## TABLE OF CONTENTS

DETAILED OPERATIVE TECHNIQUE .....	1
Surgical Site Preparation .....	1
Cut Alignment and Positioning .....	5
Tibial Size Assessment .....	13
Tibial Resection .....	16
Talar Resection .....	20
Tibial Fixation Feature Preparation .....	23
Talar Fixation Preparation .....	29
Tibial Window Preparation .....	31
Prepare and Implant the Tibial Plate .....	34
Implant Talar Component and Liner .....	38
INSTRUMENT LISTING .....	39
IMPLANT LISTING .....	46



**Figure 1**  
Position Patient

---

**SURGICAL SITE PREPARATION**

The patient is placed in the supine position. A bump is placed under the ipsilateral hip, so that the leg will not externally rotate; the patella should be facing directly anterior. Surgery is typically done under regional or general anesthesia. A thigh high tourniquet may be used. To begin the surgery, the patient is prepped, sterilized, and draped (*Figure 1*).

## DETAILED OPERATIVE TECHNIQUE

### SURGICAL SITE PREPARATION



**Figure 2**

Place Skin Incision 6-7cm Proximal to Tibiotalar Joint

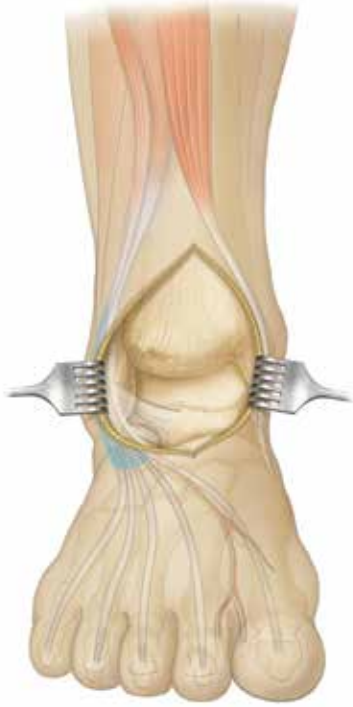

**Figure 3**

Retract for Initial Exposure

The anterior incision is made approximately 1cm lateral to the crest of the tibia. This incision should extend about 6-7cm proximal to the ankle joint and extend distally to the talonavicular joint (*Figure 2*).

Expose the extensor retinaculum. Open the extensor hallucis longus sheath; this is preferred over the anterior tibial tendon sheath to prevent "bowstringing" of the anterior tibial tendon. Once the sheath is open, identify, gently dissect and protect the deep peroneal nerve and artery throughout the entire procedure (*Figure 3*).



**Figure 4**  
Expose Bony Anatomy

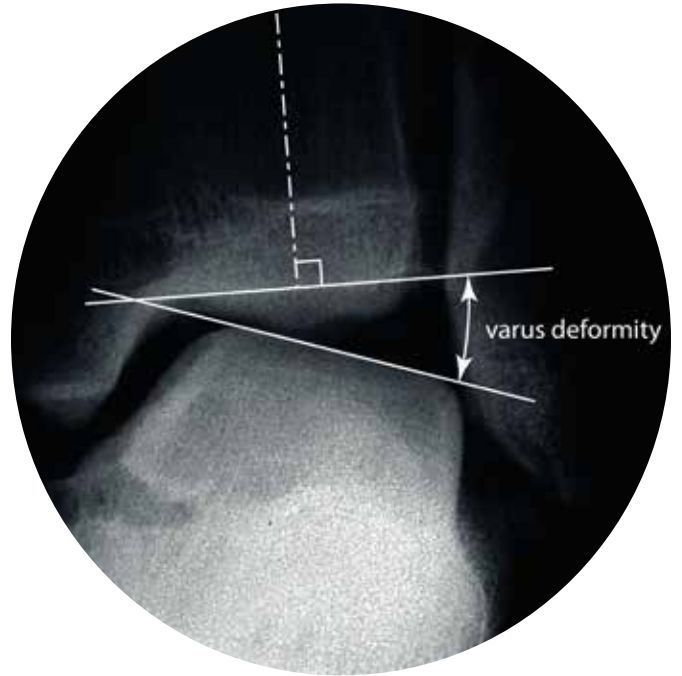

**Figure 5**  
Address Varus/Valgus Ankle

Continue exposure down to the bony anatomy. Be sure to expose from the medial malleolus to the syndesmosis in the coronal plane and all the way to the TN joint in the sagittal plane. If standard instrumentation is being used, be sure to remove any osteophytes from the anterior tibia or neck of the talus (*Figure 4*).

When using standard instrumentation, it is important to balance the ankle prior to establishing alignment and making any bony cuts. Soft tissue releases are often required to achieve this (*Figure 5*).

## DETAILED OPERATIVE TECHNIQUE

### SURGICAL SITE PREPARATION

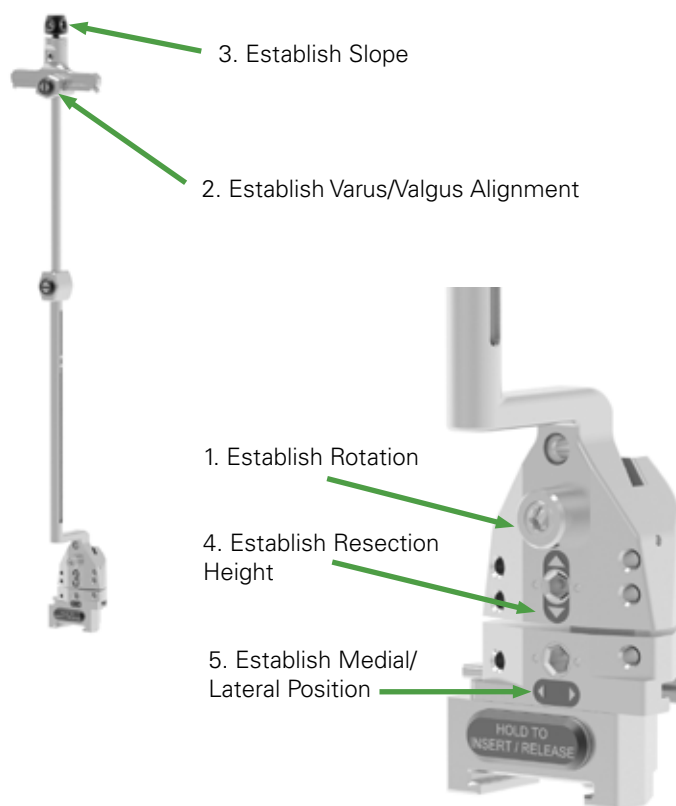

**Figure 6**  
Alignment Guide Functions

The **Tibial Alignment Guide** is used to position the cutting blocks in the following steps. To establish position (*Figure 6*):

- 1) Establish rotation (clinically assessed with the Medial Shim)
- 2) Establish varus/valgus alignment (assessed with an anterior X-ray)
- 3) Establish slope (assessed with a lateral X-ray and the Angel Wing)
- 4) Establish resection height (assessed with a lateral X-ray and the Angel Wing)
- 5) Establish medial/lateral position of the resection (clinically assessed or with an anterior X-ray).

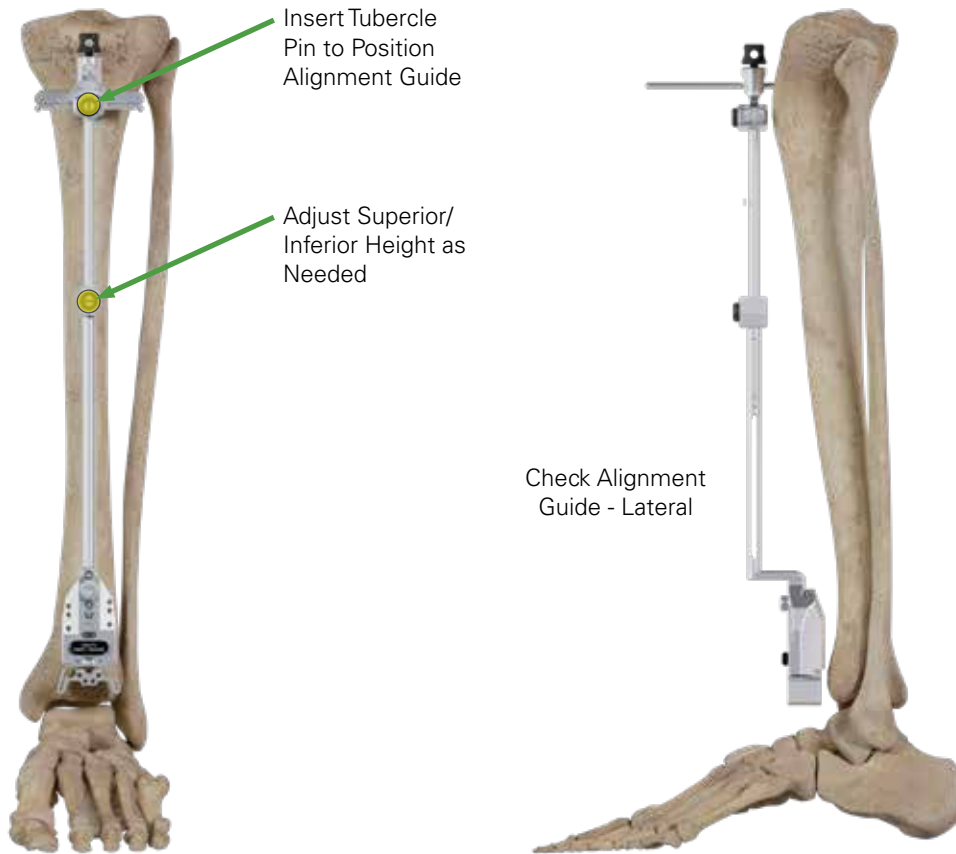

**Figure 7**  
Place Alignment Guide

#### CUT ALIGNMENT AND POSITIONING

Once the ankle joint is exposed, insert the **Medial Shim** between the talus and medial malleolus. Make a small 5mm incision over the tibial tubercle.

Use the rotation of the Medial Shim to align the **Tubercle Pin** prior to insertion. The pin should be perpendicular to the anterior cortex of the tibia.

**Note:** Care should be taken to avoid tilting the tubercle pin superior as this can prevent the distal block from contacting the anterior cortex.

Once the pin is inserted, place the **Tibial Alignment Guide** over the tubercle pin.

Provisionally select the appropriately sized **Tibial Cutting Block** and attach it to the Alignment Guide (final size selection will be performed in later steps). Press and hold the button in the middle of the shaft to adjust the length of the guide. Align the guide such that the distal end of the Tibial Cutting Block is roughly aligned to the anterior tibial cortical rim (*Figure 7*).

#### » SURGICAL PEARL

The distal portion of the Tibial Alignment Guide should be half-opened prior to placement to allow for later superior or inferior adjustments.

## DETAILED OPERATIVE TECHNIQUE

### CUT ALIGNMENT AND POSITIONING



**Figure 8**  
Provisionally Fix Alignment Guide



**Figure 9**  
Unlock/Lock Rotation

Once the length of the guide is adjusted, center the distal alignment guide over the distal tibia. Place a provisional pin in the most proximal hole of the Alignment Guide. This will hold the position of the distal block and allow minor adjustments proximally (*Figure 8*).

#### ► SURGICAL PEARL

Small adjustments may be made to the superior/inferior height and slope once the pin is placed, however larger adjustments may require repositioning of the distal pin.

To adjust the rotation, first build the screwdriver by mating the **Impactor Handle** to the **1/8" Standard Hex Driver**. Next, insert the driver into the center locking hex mechanism and turn counterclockwise to enable rotation of the distal block. Turn clockwise again to lock rotation (*Figure 9*).

## DETAILED OPERATIVE TECHNIQUE

### CUT ALIGNMENT AND POSITIONING



**Figure 10**

Adjust Tibial Block Rotation with Alignment Rod

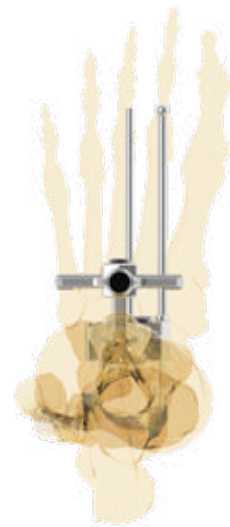

**Figure 11**

Confirm Rotation

Place the **Rotation Alignment Rod** into the Tibial Cutting Block.

Adjust rotation of the distal block until the Alignment Rod is parallel to either the Medial Shim, or the second or third ray of the foot, based on user preference. This orientation will guide the rotation of the tibial implant and prevent inadvertent resection of the posteromedial portion of the medial malleolus (*Figure 10*).

**Note:** In loose ankles or those with valgus deformity, the medial shim may not stay in place. In these cases, the alignment rod may be oriented with the second or third ray.

 An A/P image can be taken to confirm appropriate alignment. The hole in the center of the block must appear as a perfect circle and the cut slots must be visible to ensure that a true anterior view is achieved. In this orientation, verify that the mortise view is visible (*Figure 11*).

 Signifies fluoroscopic image

## DETAILED OPERATIVE TECHNIQUE

### CUT ALIGNMENT AND POSITIONING

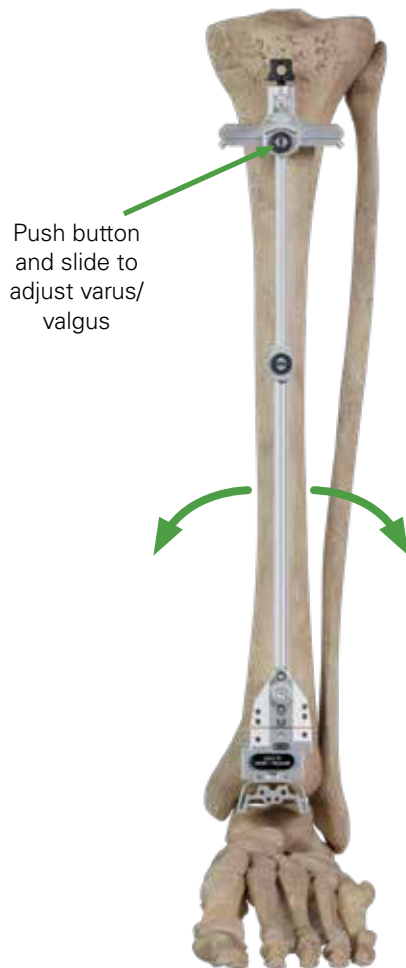

**Figure 12**  
Adjust Varus/Valgus Alignment

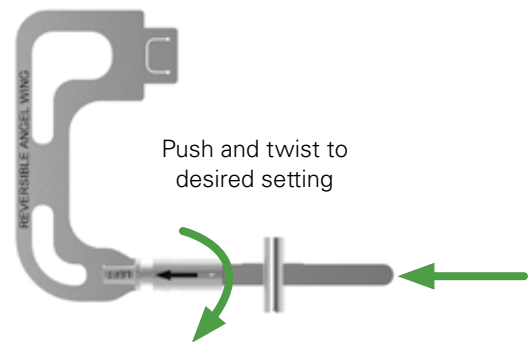

**Figure 13**  
Adjust Angel Wing

Varus/valgus alignment of the guide should be confirmed using the c-arm. Adjustments can be made by pushing the proximal button and sliding the proximal shaft medial or lateral (Figure 12).

 Take an anterior-posterior X-ray to confirm varus/valgus alignment. When assessing varus/valgus, anterior-posterior X-rays at both the joint and midshaft of the tibia may help to greater identify the axis of the tibia.

#### » SURGICAL PEARL

In most cases, appropriate alignment can be achieved by ensuring that the alignment guide is parallel to the lateral border of tibia.

Remove the Rotation Alignment Rod. Adjust the **Reversible Angel Wing** to the appropriate operative side by pushing in and twisting 180° (Figure 13).



**Figure 14**  
Insert Angel Wing

Insert the Angel Wing into the Tibial Cutting Block. The radiographic markers should be distal to the cutting guide (Figure 14). The Angel Wing allows the user to visually assess the slope and tibia resection height.

To adjust the slope, loosen the proximal knob and shift the Alignment Guide anterior/posterior along the Tubercle Pin, then tighten the proximal knob (Figure 15).

#### » SURGICAL PEARL

The Hex Driver may be inserted into the holes of the proximal knob to provide additional torque when tightening.

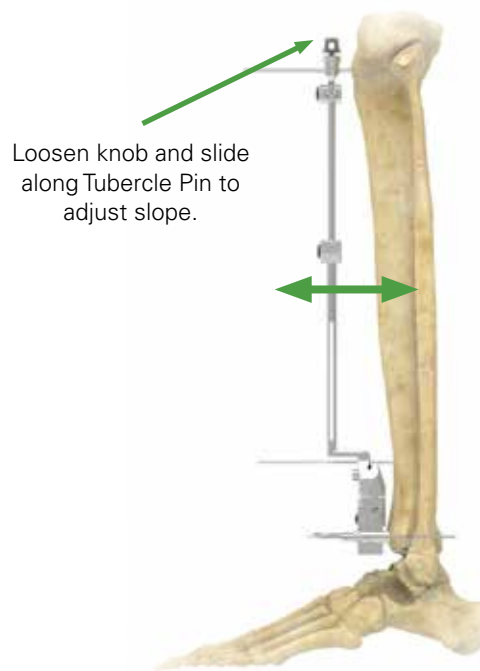

**Figure 15**  
Adjust Slope

#### » SURGICAL PEARL

Some users may wish to bias toward a slightly open resection (i.e. 1-2° of dorsiflexion) based on their surgical experience and preferences.

**Note:** It may be necessary to extend/contract the alignment guide in the superior/inferior direction using the center button to allow travel along the proximal pin.

## DETAILED OPERATIVE TECHNIQUE

### CUT ALIGNMENT AND POSITIONING

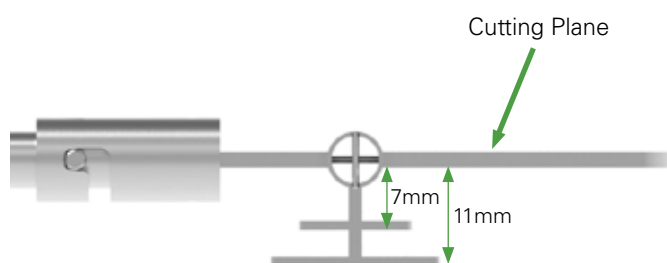

**Figure 16**  
Angel Wing Height Indicators

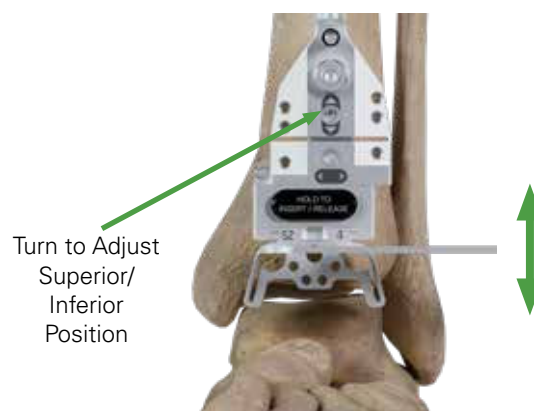

**Figure 17**  
Adjust Superior-Inferior Position

**Note:** The Reversible Angel Wing provides the user with 7mm and 11mm height indications on a lateral radiographic view.

An 11mm resection height is recommended. However, alternate resections may be used at the discretion of the user based on joint laxity/tightness present and surgical preference (Figure 16).

The level of the cut may be moved by inserting the Hex Driver into the imaged superior-inferior adjustment feature on the Alignment Guide. Press firmly into the hex until it is fully depressed and begin rotating the driver to adjust height (Figure 17).

**Note:** When removing the hex driver, confirm that the female hex feature returns to its original un-depressed position. In the event that the feature is still depressed, reinsert the driver and rotate slightly clockwise or counterclockwise until the hex returns to its original position.



**Figure 18**  
Misaligned Lateral View Plane

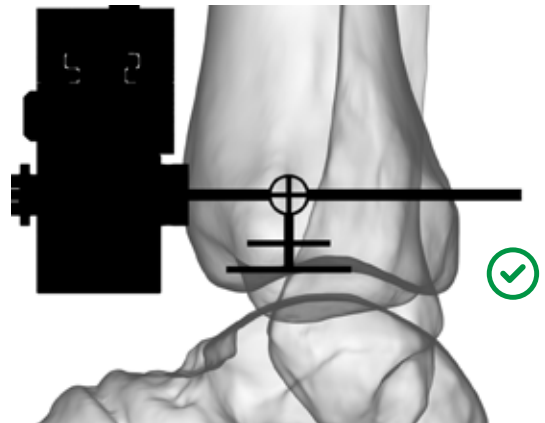

**Figure 19**  
Correctly Aligned Lateral View Plane

 A lateral fluoroscopic image should be taken at this point to assess the slope of the tibial cut and the position of the cut relative to the plafond. The center alignment feature must present as a perfect circle to verify that a true lateral view is achieved (*Figures 18 and 19*).

At this point, the user should perform any final adjustments to slope and reconfirm adjustments with additional lateral fluoroscopic images as necessary.

 Signifies fluoroscopic image

## DETAILED OPERATIVE TECHNIQUE

### CUT ALIGNMENT AND POSITIONING

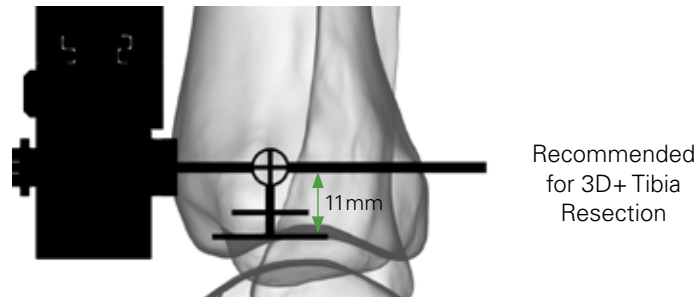

**Figure 21**

Adjust Slope and Resection Height Under Lateral X-ray

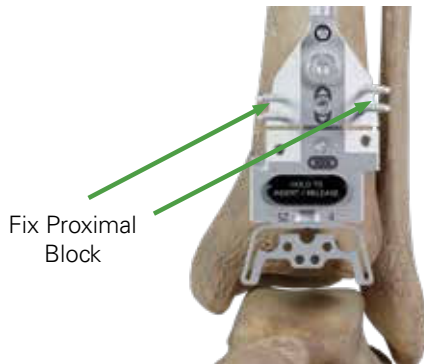

**Figure 20**

Pin the Proximal Block for Stability

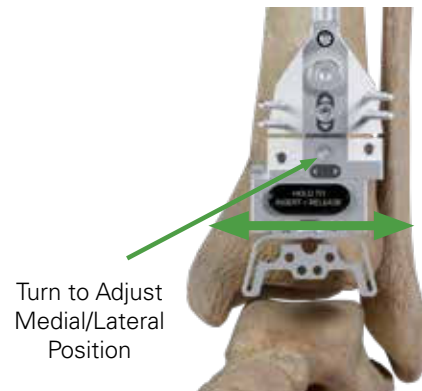

**Figure 22**

Trial Preliminary Medial-Lateral Position & Cutting Block Size

When the proper rotation, varus/valgus, and slope are achieved, pin the upper portion of the Alignment Guide in any of the holes depending on the best bony purchase (*Figure 20*). Note that modifications to cut height and medial/lateral position may still be made after this step.

#### ► SURGICAL PEARL

Proximal holes are symmetric, however the tibial bone tends to bow lateral, so care should be taken to ensure the pin holes being used proximally are overlying bone.

 Under a lateral X-ray, assess the resection height. If using the recommended resection height (11mm), the longer line should be tangent with the top of the tibial plafond. Alternate resection heights may be used at the user's discretion, such as when operating on an ankle with laxity (*Figure 21*).

Use the Hex Driver to adjust the medial-lateral position of the Tibial Cutting Block (*Figure 22*). For the size assessment in the following steps, it is recommended that the Tibial Cutting Block be initially positioned over the midline of the distal tibia. Further adjustments in medial-lateral offset may be performed in later steps.



**Figure 23**  
Insert Drill Guide

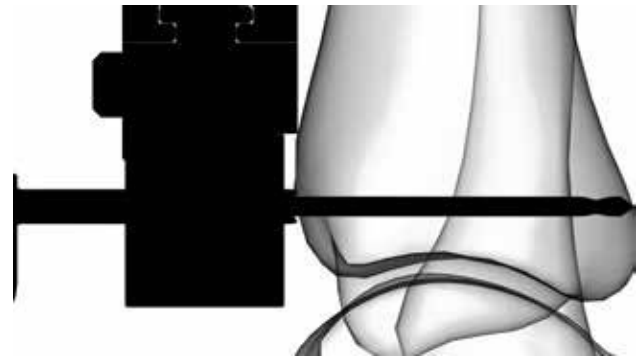

**Figure 24**  
Create Bicortical Drill Hole

**TIBIAL SIZE ASSESSMENT**

Tibial size selection is performed by assessing anterior-posterior tibial length and available medial-lateral space at the desired resection height. It is recommended that the anterior-posterior length be used as a primary sizing variable, while the medial-lateral assessment be used as a secondary sizing variable to confirm that the desired size is appropriate for the patient anatomy. However, the user may optionally prioritize medial-lateral space as their primary indicator based on their surgical preferences.

Insert the **AP Sizer Drill Guide** through the center hole of the Tibial Cutting Block. The drill guide should make firm contact with the anterior tibial cortex (*Figure 23*).

Drive the **AP Sizer Drill** under power through the Drill Guide, until the posterior cortex is breached (*Figure 24*). At this point, examine the visible drill bands above the drill guide to identify the tibial plate size corresponding to the depth of the prepared hole. To ensure an accurate reading, the drill tip should be flush with the back of the posterior cortex.

 A lateral fluoroscopic image may optionally be taken at this point to confirm that the drill is flush with the posterior tibial cortex and is not protruding into the posterior soft tissues.

 Signifies fluoroscopic image

## DETAILED OPERATIVE TECHNIQUE

### TIBIAL SIZE ASSESSMENT



**Figure 25**  
Identify Size from A/P Depth



**Figure 26**  
Measure A/P Depth Using AP Size Indicator

In the indicated image, a size 4 plate would be recommended based on the anterior-posterior length (*Figure 25*).

#### ► SURGICAL PEARL

If the size reading is between two sizes, it is recommended that the user selects the larger tibial size to ensure complete anterior and posterior cortical coverage of the implant.

If preferred, the user may choose to instead measure the depth of the hole using the **AP Size Indicator**. Insert the probe into the prepared sizing hole and hook the posterior tibial cortex. Allow the slide of the size indicator to contact the anterior cortex, then note the indicated tibial plate size (*Figure 26*).

Attach the final Tibial Cut Block based on the previous sizing steps. Adjust the medial/lateral position as necessary and confirm that the determined size is appropriate for the distal tibial anatomy. It is recommended that the medial shoulder be in line with plane of the medial malleolus. If the medial/lateral anatomy of the tibia is too small for the chosen size, the user may downsize to better match the medial/lateral constraints of the bone.

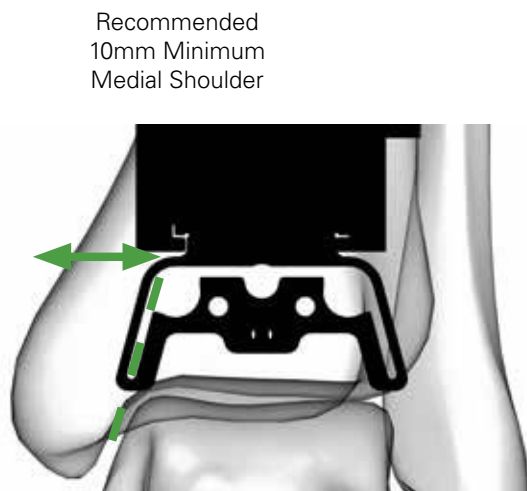

**Figure 27**

Confirm Size Selection and Medial-Lateral Offset

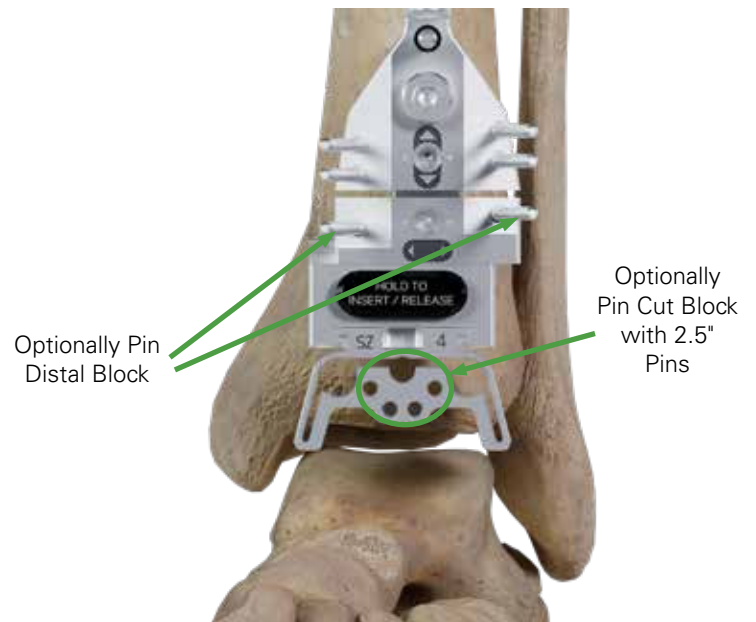

**Figure 28**

Optionally Pin Distal Block

 An anterior fluoroscopic image may optionally be taken at this point to assess the medial-lateral footprint of the chosen size cut block (Figure 27).

When the final superior-inferior height, medial-lateral offset, and component size has been determined, the distal holes of the Alignment Guide may be optionally pinned for additional cut block security (Figure 28).

The pin holes of the cut block may also be optionally used for additional security. When using these pin holes, 2.5" pins should be used.

**Note:** Only one oblique pin may be used at a time.

 Signifies fluoroscopic image

## DETAILED OPERATIVE TECHNIQUE

### TIBIAL RESECTION

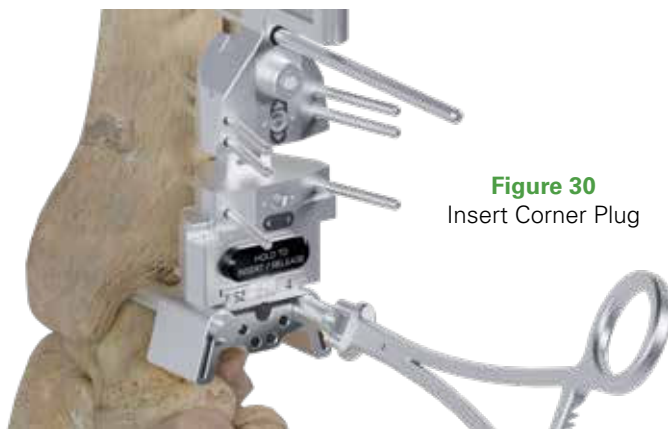

**Figure 30**  
Insert Corner Plug



**Figure 29**  
Drill Corners



**Figure 31**  
Create Tibial Resection

### TIBIAL RESECTION

Use the **Corner Drill** to prepare the rounded corners of the tibial resection (Figure 29).

**Note:** Care should be taken to avoid the posterior soft tissues during tibial preparation.

Use the **Scissor Handle** to insert a **Corner Plug** after drilling each hole to guard against off-axis preparation (Figure 30).

Cut the distal tibia using an oscillating saw, taking care not to penetrate through the posterior capsule where the neurovascular bundle is located. A small reciprocating saw is used to cut the bone along the medial and lateral slots (Figure 31).

**Note:** When using smaller tibial cut blocks, it can be difficult to cut through the proximal slot with both corner plugs present. In such cases, the user may prefer to use one plug at a time, angling the saw blade slightly toward the plug.

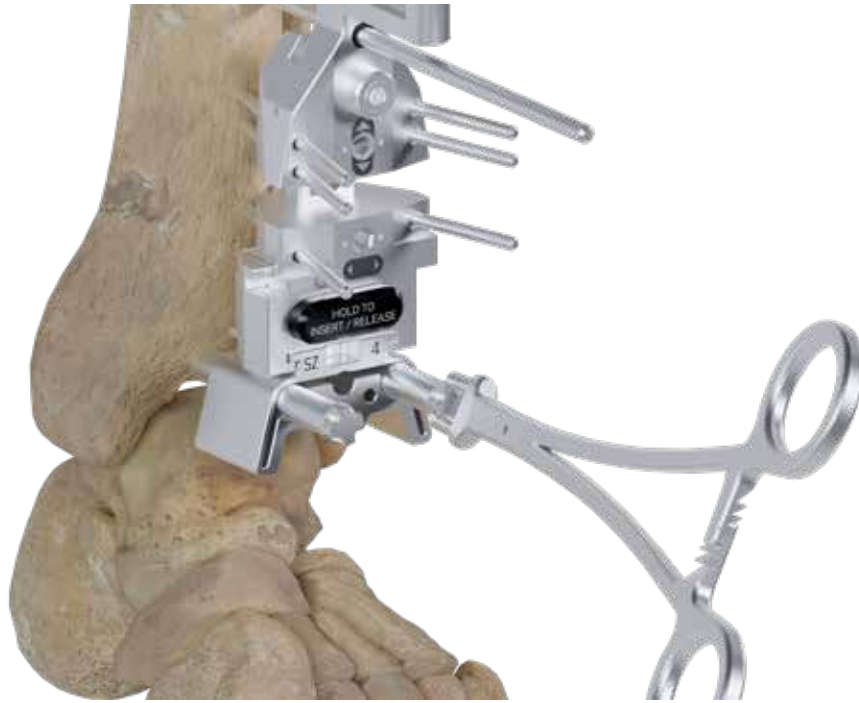

**Figure 32**  
Remove Corner Plugs with Scissor

---

Remove the corner plugs (*Figure 32*).

## DETAILED OPERATIVE TECHNIQUE

### TIBIAL RESECTION

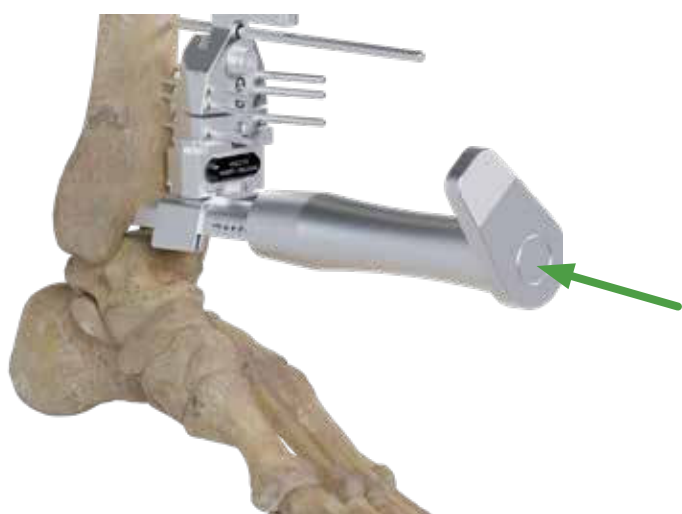

**Figure 33**

Optionally Complete Corners with Corner Chisel

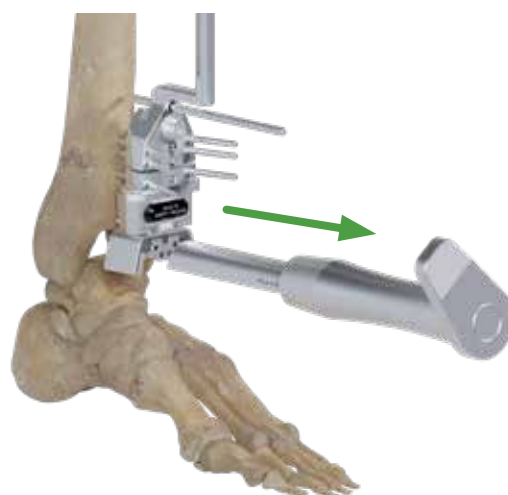

**Figure 34**

Optionally Apply Retrograde Impaction to Free Chisel

The surgeon may optionally impact the **Corner Chisel** in the posterior direction into the medial and lateral corners of the cut block to clear any remaining attached bone (Figure 33).

The size markings indicate an appropriate chisel depth based on overall anterior/posterior length of the designated size. However, posterior tibial curvature may result in a shorter depth along the corner of the cut. Users must employ their surgical judgment to evaluate when the posterior bone has been fully cleared.

**Note:** Ensure that the distal tibia has been fully cut through the posterior tibial cortex before proceeding. Attempting to use the Corner Chisel to punch through an incomplete posterior cortical cut may require excessive force that could lead to damage of the posterior soft tissues. Additionally, a higher strike force may also increase the risk of fracturing the medial malleolus. Do not toggle the Corner Chisel in a medial/lateral direction, as doing so may fracture the medial malleolus.

If the chisel is wedged in the resection, the user may lightly apply retrograde impaction to the strike plate to free the chisel (Figure 34).

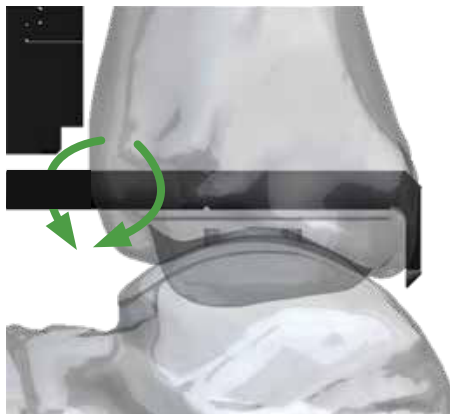

**Figure 35**

Release Posterior Soft Tissues

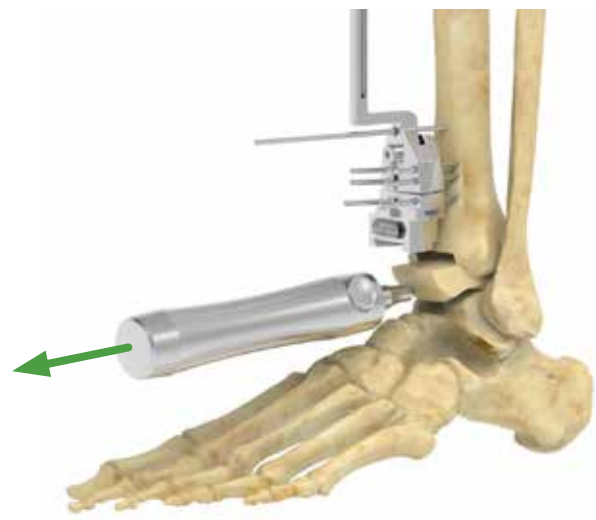

**Figure 36**

Drive In Tibial Bone Removal Screw and Apply Tension

Remove the tibial cut block and the resected tibial bone. To aid in removal, the user may do one or more of the following based on their surgical preferences:

- Cut the bone into small pieces with the reciprocating saw, then use a rongeur to remove the bone until all bone is cleared from the joint.
- Attach the **Posterior Capsule Release Tool** to the Impactor Handle, and insert the tip of the device through the joint space and/or the proximal tibial cut line. With the tip posterior to the resected bone, begin rotating/sweeping the device to release the posterior joint capsule from the resected bone (*Figure 35*).

- Drive the **Tibial Bone Removal Screw** into the distal tibial resection bone block, taking care to not damage the posterior soft tissues. Attach the Impactor Handle to the Tibial Bone Removal Screw. Apply tension in the anterior direction to remove the resected bone, using a scalpel or Posterior Capsule Release Tool to release the exposed posterior soft tissues where necessary (*Figure 36*).

## DETAILED OPERATIVE TECHNIQUE

### TALAR RESECTION

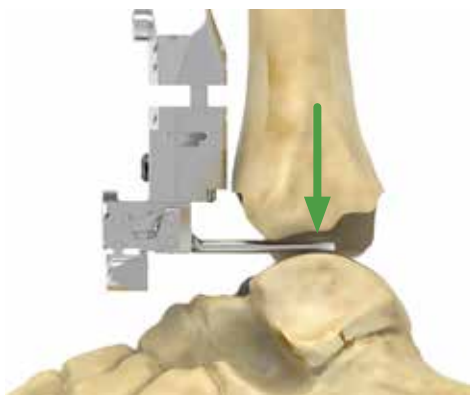

**Figure 37**

Insert Adjustable Talar Cutting Block

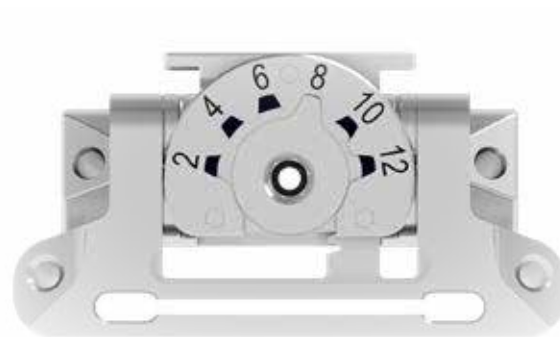

**Figure 38**

Set Talar Resection Height

### TALAR RESECTION

After clearing the resected tibial bone, the **Adjustable Talar Cutting Block** is placed onto the Alignment Guide. Remove any pins from the distal block of the Alignment Guide. Pins in the proximal block should be kept in place to maintain alignment. The adjustable talar cutting block should be extended as far as possible distally, using the superior-inferior adjustment on the alignment guide (unpin the distal block of the alignment guide as necessary). This will allow for proper tensioning of the soft tissues.

**Note:** Care should be taken to ensure the paddle is both contacting the talar bone and centered on it (Figure 37).

Use the hex driver to adjust to the desired resection height. A 8-10mm cut is standard for a flat cut talus approach (Figure 38).

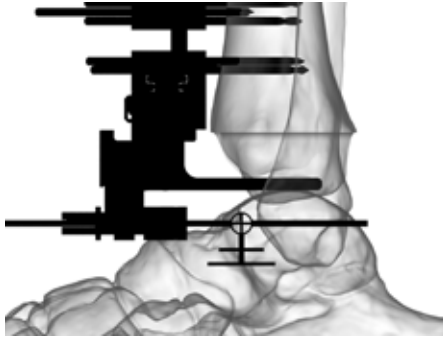

**Figure 40**

Evaluate Talar Resection Plane Orientation and Height



**Figure 39**

Insert Angel Wing Into Talar Cut Block

Optionally Pin Proximal Block After Cut Slope & Varus/Valgus Orientation is Confirmed

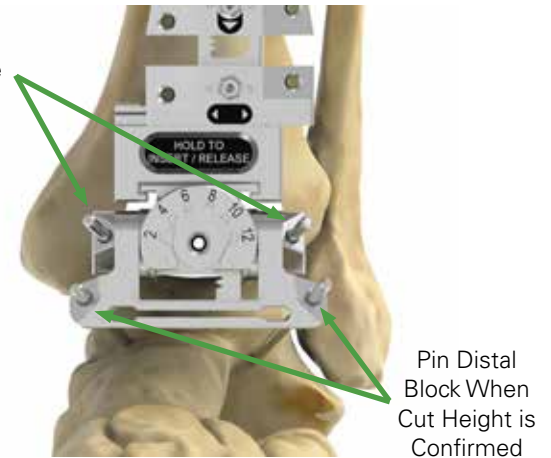

**Figure 41**

Pin Block and Resect Talus

Insert the Angel Wing into the cutting slot of the block (*Figure 39*).

Hold the foot in neutral dorsiflexion and the heel in slight valgus. A lateral fluoroscopic image should be taken at this point to assess the plane of talar cut. Ensure that the Angel Wing is at its thinnest and that the barrel appears as a thin circle. At this point, also confirm that the tongue of the cut block is contacting the talar dome. The slope may be adjusted by plantar flexing/dorsiflexing the foot or by sliding the proximal guide along the tubercle pin shaft (*Figure 40*).

If the cut plane orientation and the cut height have been finalized, the user may pin the distal two pin holes of the talar cutting block. Alternatively, if the user intends to make further adjustments to the resection height, the two proximal pin holes may be used to lock the cut plane orientation while the height is finalized. At the point where resection height is confirmed, the distal pins should be used to lock the distal block, and the proximal pins should be removed (*Figure 41*).

Remove the Angel Wing and resect the talar dome with the oscillating saw.

## DETAILED OPERATIVE TECHNIQUE

### TALAR RESECTION



**Figure 42**  
Insert Flat Cut Talus Gap Check Tool



**Figure 44**  
Insert Window Checker



**Figure 43**  
Construct Height Representation

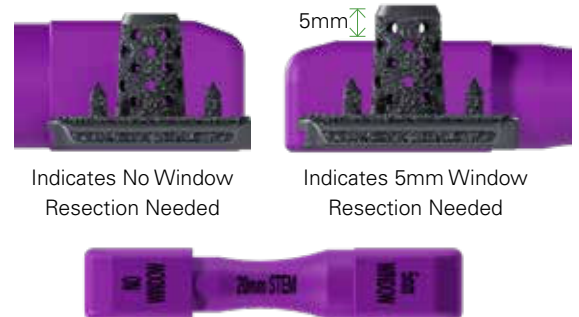

**Figure 45**  
Identify Window Height

Remove the Cut Block and clear the resected bone. Insert the **Flat Cut Talus Gap Check Tool** (Figure 42).

The thickness of the Gap Check Tool corresponds to the minimum construct thickness for a given range of flat cut talus sizes (Figure 43). Note that all sizes of the tibial component have an identical thickness.

If the Gap Check Tool cannot be inserted into the joint space, additional tibial/talar bone must be resected to ensure sufficient space is made for the implant construct.

Insert the appropriate Window Gap Check Tool (Figure 44).

This provides an indication of the minimum window height required in order to insert the desired tibial implant stem, in consideration of joint laxity and resections (Figure 45).

**Note:** If the end of the Window Gap Check Tool indicating “no window” can comfortably fit within the joint space, then a window isn’t necessary.

#### » SURGICAL PEARL

Do not remove the Alignment Guide until sufficient joint space is verified with the gap check tool. This will make the process easier if a recut is necessary.

**Figure 46**  
Remove  
Alignment Guide



**Figure 47**  
Insert Punch Guide

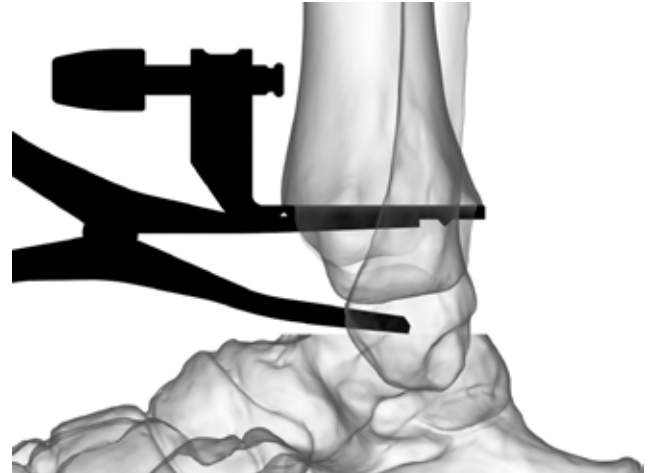

**Figure 48**  
Confirm Punch Guide is Seated

Once all gap checks are completed, unpin and remove the Alignment Guide (*Figure 46*).

» **SURGICAL PEARL**

The user may optionally keep the Proximal Tubercle Pin in place in the event that additional resections are deemed necessary later in the case.

**TIBIAL FIXATION FEATURE PREPARATION**

Insert the **Punch Guide** that corresponds to the chosen Tibial Cut Block size. Use the **Lamina Distractor** to apply joint tension and ensure the punch guide is flush with the tibial resection (*Figure 47*).

 A lateral fluoroscopic image should be taken at this point to confirm that the Punch Guide is fully seated and no posterior liftoff is present. Note that markers for the fixation feature locations will likely be occluded by the distractor in this view (*Figure 48*).

 Signifies fluoroscopic image

## DETAILED OPERATIVE TECHNIQUE

### TIBIAL FIXATION FEATURE PREPARATION



**Figure 49**  
Provisionally Secure Tibial Punch Guide

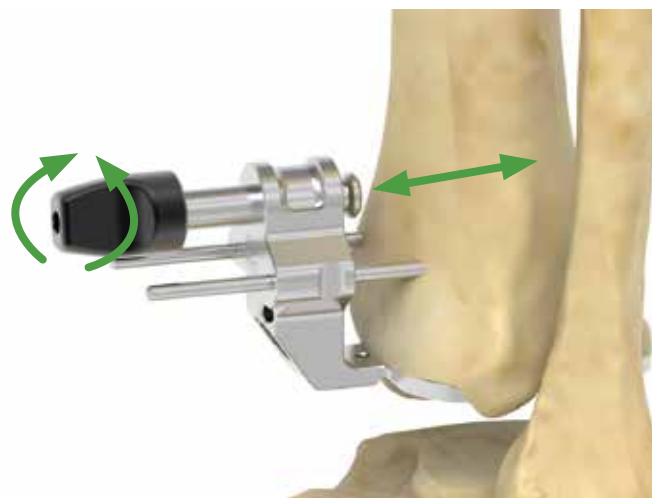

**Figure 50**  
Adjust Anterior-Posterior Position

When the desired tibial component slope is achieved, the user may optionally pin both parallel pin holes. This will allow the user to remove the distractor while retaining orientation of the Tibial Punch Guide and allow for visualization of the fixation feature locations in a lateral X-ray. Adjustments to anterior/posterior position of the punch guide may be made after this step (Figure 49).

**Note:** The parallel pins are mandatory if the user intends to create an anterior tibial window based on the prior gap assessment.

If the parallel pin holes are not used, the distractor should remain in place until the punch guide is secured with oblique pins. Once again, adjustments to anterior/posterior position of the punch guide may be made up until the oblique pins are inserted.

Shift the anterior-posterior offset of the Tibial Punch Guide by adjusting the knob either by hand or with the hex driver (Figure 50).



**Figure 51**  
Optionally Insert Pin for Anterior Hard Stop

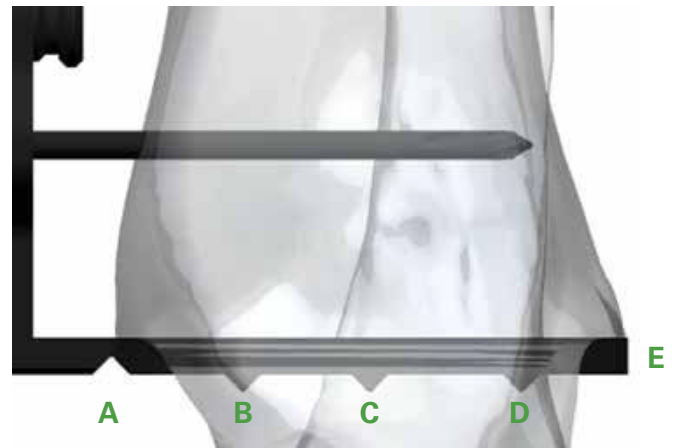

**Figure 52**  
Confirm Anterior-Posterior Offset in Lateral View

**Note:** The Tibial Punch Guide features a pin hole which has a trajectory that aligns to the anterior border of the implant. If desired, the user may back the knob fully out, then insert a temporary 2.5" pin through this hole to act as a hard stop for adjustment of the Punch Guide, such that the final implant positioning will be flush with the anterior tibial cortex. The pin may be secured in place by gently tightening the screw to apply pressure to the pin. The punch guide position is then secured using the oblique pins, and the temporary hard stop pin is removed (Figure 51).

 A lateral fluoroscopic image should be taken at this point to confirm that the desired anterior-posterior offset is achieved. A true lateral view is confirmed when the Punch Guide appears as a thin line with visible "V"-shaped features (Figure 52). These features correspond to the:

- A. Anterior border of the implant
- B. Position of the anterior pegs
- C. Position of the center cage
- D. Position of the posterior peg
- E. Posterior border of the implant

 Signifies fluoroscopic image

## DETAILED OPERATIVE TECHNIQUE

### TIBIAL FIXATION FEATURE PREPARATION

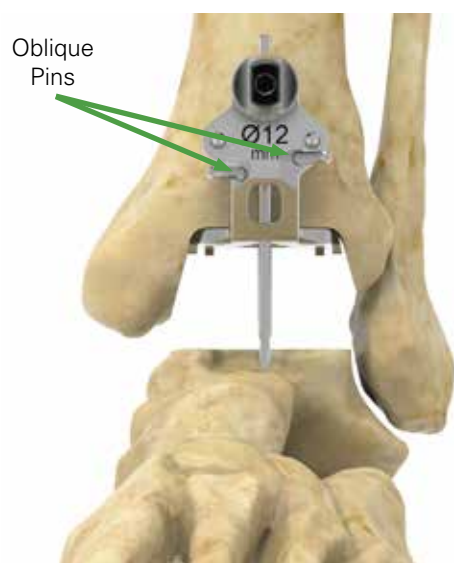

**Figure 53**  
Insert Oblique Pins



**Figure 54**  
Punch Peripheral Holes

Secure the Tibial Punch Guide by pinning at least one of the two oblique pin holes (*Figure 53*).

Attach the **Peripheral Peg Punch** to the **Modular Impactor Arm**. Align the punch to the three peripheral peg holes of the Punch Guide. Impact in the proximal direction until the punch is fully seated. Repeat for all peripheral peg holes (*Figure 54*).

## DETAILED OPERATIVE TECHNIQUE

### TIBIAL FIXATION FEATURE PREPARATION

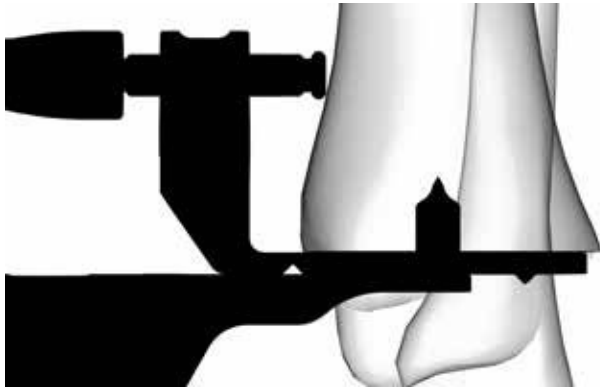

3D+ Tibial Plate Size	Base Cage Diameter	Reamer Diameter
Size 1	12mm	10mm
Size 2	12mm	10mm
Size 3	13mm	11mm
Size 4	14mm	12mm
Size 5	15mm	13mm
Size 6	16mm	14mm



**Figure 55**

Optionally Use Cruciform Punch



**Figure 56**

Select Reamer Size

The subsequent steps describe center hole preparation through reaming. In cases of sclerotic bone, the user may optionally initiate the hole preparation by attaching the **Cruciform Punch** to the Modular Impactor Arm and impacting through the center hole of the punch guide. Applying a light torque and/or repunching may aid with clearing bone (*Figure 55*).

Select the appropriately sized 15mm tall **Reamer** based on the marking located on the front of the punch guide. Insert the tip into the joint and align to the center hole of the punch guide (*Figure 56*).

## DETAILED OPERATIVE TECHNIQUE

### TIBIAL FIXATION FEATURE PREPARATION



**Figure 57**  
Prepare Center Hole

Insert the **Lamina Distractor** inferior to the reamer, such that the male nub of the reamer mates to the hole of the distractor paddle. Begin slowly distracting the joint while applying a ratchet-style rotation motion to the reamer. Use a full arc of motion but avoid contacting the bony shoulders with the reamer handle. Continue spreading and rotating the reamer until it sits flush with the punch guide (*Figure 57*).

As joint space permits, taller reamers of the same diameter may be used through the punch guide as previously described to achieve the preparation depth for the intended stem length. The depth of the prepared hole will be 3mm shorter than the reamer length, due to the thickness of the punch guide.

**Note:** *If the final intended hole depth cannot be achieved at this stage, additional reaming may be performed later in the procedure after the punch guide is removed.*

#### » SURGICAL PEARL

Based on surgical preference, the user may choose at this stage to immediately implant the tibial component (ref. Figures 64-77) so that the subsequent talar preparation steps may be performed without tibial pins present. In this case, the user should remove the tibial pins and punch guide, perform the implantation steps described in Figures 64-77, then return to this step to position the trial. Note that instead of using the punch liner, the appropriate sized liner trial may be used to tension the joint.



**Figure 58**  
Insert Punch Liner



**Figure 59**  
Insert Talar Trial Component

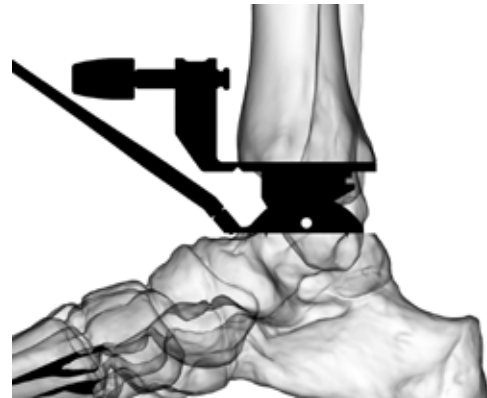

**Figure 60**  
Use Fluoroscopic Imaging to Ensure Complete Coverage

**TALAR FIXATION PREPARATION**

Insert the desired size **Flat Cut Talar Trial** using the **Scissor Style Inserter**. Check to ensure the trial covers the bone medial to lateral without overhang into the gutters in order to avoid impingement. The flange/scissor handle is meant to align rotationally with the second or third ray with the ankle in neutral flexion (*Figure 58*).

**Note:** *If upsizing the talar component by two or more sizes relative to the tibial component, additional preparation of the bony shoulders of the tibia may be necessary. Clearance will be confirmed later in the procedure when the liner trial is inserted.*

Insert the desired thickness **Punch Liner** corresponding to the Talar Trial size using the Scissor Style Inserter. Assess range of motion for the construct and adjust the talar trial position as necessary for optimal coverage and joint motion (*Figure 59*).

 A lateral fluoroscopic image should be taken to confirm that the circular fluoroscopic hole appears directly over the lateral talar process. Anterior/posterior coverage of the talus should also be assessed at this stage (*Figure 60*).

 Signifies fluoroscopic image

## DETAILED OPERATIVE TECHNIQUE

### TALAR FIXATION PREPARATION



**Figure 61**  
Pin Talar Component



**Figure 62**  
Drill Two Anterior Holes

Pin the talar trial (*Figure 61*). Remove the Punch Liner, Punch Guide Oblique pin(s), and the Punch Guide.

**Note:** *The punch guide parallel pins should remain in place if the user intends to make an anterior window to facilitate implantation.*

Use the **Talus Drill** under power to prepare the two anterior holes in the trial (*Figure 62*).



**Figure 63**  
Drill Central Hole for Cage



**Figure 64**  
Achieve Final Center Hole Depth



**Figure 65**  
Attach Anterior Window Cut Block

Use the **Coring Drill** under power to prepare the center hole for the cage (*Figure 63*).

#### » SURGICAL PEARL

The Coring Drill is cannulated. A pin or K-wire up to 3.2mm in diameter can be used to clear the bone from the drill. This bone could be used in the cage of the talar implant.

Remove the oblique pins and Talar Trial. If the joint space was previously insufficient to allow for use of the appropriate length reamer (page 28), the user should now chase the center cage hole with the reamer length matching the intended stem length to achieve the final depth (*Figure 64*). If implanting a stem longer than 20mm, additional prep height may be achieved using the **Tall Cage Punch** in the subsequent steps.

**Note:** The final reamer diameter identified in the table on page 27 will provide a 2mm diametric press-fit at the base of the cage. The user may at this stage employ their surgical discretion to chase the center cage hole with an upsized reamer to reduce the resultant implant press-fit as needed based on the patient bone quality.

#### TIBIAL WINDOW PREPARATION

If a window was deemed unnecessary during the window sizer assessment step (*Figure 44*), skip ahead to *Figure 70*. Select the **Anterior Window Cut Block** corresponding to the size of the intended tibial plate. Attach the cut block to the parallel pin holes based on the desired window height established during the window sizer step (*Figure 65*).

## DETAILED OPERATIVE TECHNIQUE

### TIBIAL WINDOW PREPARATION



**Figure 66**

Secure Anterior Window with Oblique Pin(s)

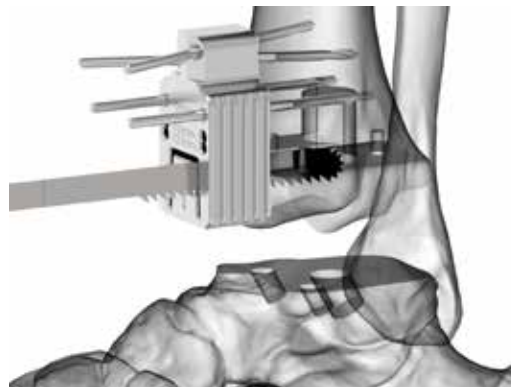

**Figure 67**

Create Partial-Depth Window Resections

Ensure the cut block is flush against the anterior tibial cortex, and secure in place using oblique pin(s) (*Figure 66*).

Using a reciprocating saw, cut through the anterior half of the tibia until the window resection is freed from the bone, or a tactile decrease in resistance can be detected, indicating that the saw blade has entered the void created by the previous reamer steps. Repeat for all three cutting slots (*Figure 67*).

**Note:** The saw blade should not be plunged fully through the tibia.



**Figure 68**  
Remove Cut Block and Window Resection

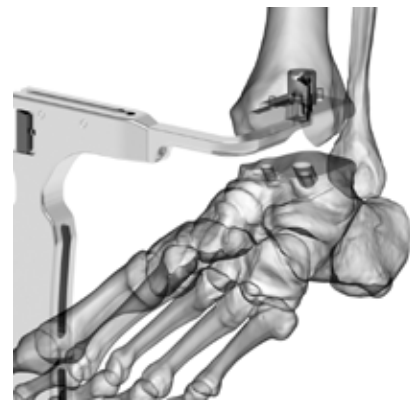

**Figure 69**  
Optionally Use Tall Cage Punch

Remove the oblique pins and the Anterior Window Cut Block. Leave the parallel pins in place. Remove the resected bone window and reserve this as grafting material (*Figure 68*).

If implanting a plate with a >20mm tall cage, the user may optionally assemble the Tall Cage Punch to the Modular Impactor Arm and impact it through the opening in the window to achieve up to 20mm of additional depth beyond the height of the window (*Figure 69*).

## DETAILED OPERATIVE TECHNIQUE

### PREPARE AND IMPLANT THE TIBIAL PLATE



**Figure 70**

Apply Cement to the Tibial Component

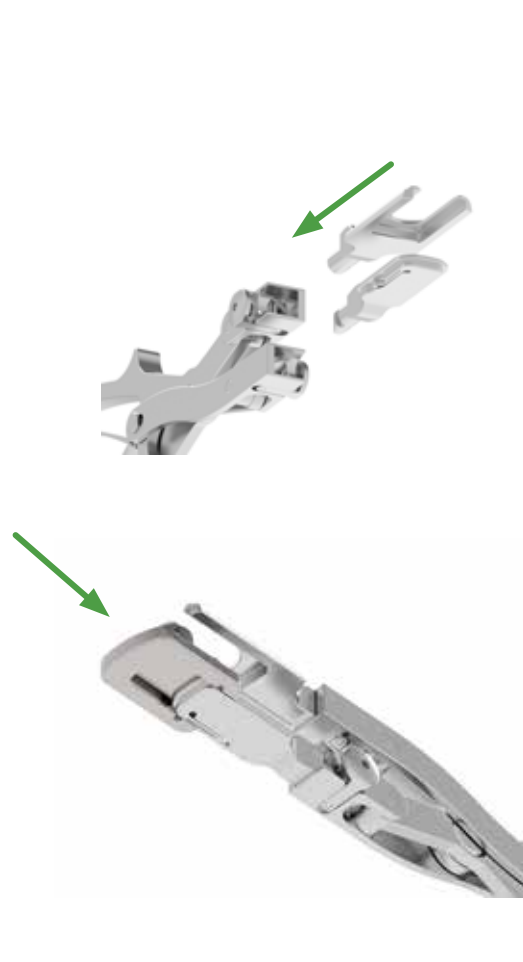

**Figure 71**

Attach Tibial Implant to Inserter

### PREPARE AND IMPLANT THE TIBIAL PLATE

Prepare cement and apply to the desired regions of the tibial component (*Figure 70*).

#### » SURGICAL PEARL

The user may optionally pack the tibial cage with autograft harvested throughout the procedure.

Tibial plate insertion can be accomplished using either the **Tibial Inserter** or the **Modular Distractor** assembly, depending on user preference. The subsequent section describes use of the Modular Distractor; refer to OPTECH-000171 pg 32 for instructions on the Tibial Inserter.

Assemble the **Tibial Inserter Tip** and the appropriately sized **Fork Distractor Tip** to the Modular Distractor. Gently insert the Tibial Inserter Tip into the tibial implant female T-slot until the device snaps into the locking clip notch. Take care not to scratch the T-slot interface (*Figure 71*).

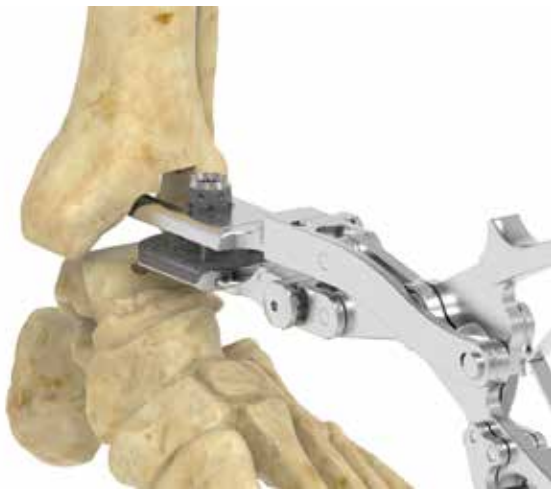

**Figure 72**  
Align Implant to Joint

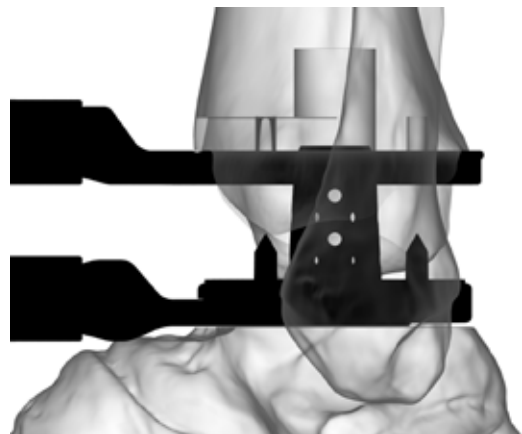

**Figure 73**  
Spread Distractor and Insert Implant

Align the implant to the prepared joint (ensuring the stem is positioned to enter the window, where applicable). The handle should be spread to a partially open position such that the Fork Distractor Tip makes contact with the distal tibial resection (*Figure 72*).

Push the assembly into place, spreading the joint as necessary by opening the distractor to achieve the necessary joint space (*Figure 73*).

When the implant cage is positioned inferior to the prepared center cage hole, release the distractor and allow the implant to partially insert into the tibia. Note that the notch on the proximal face of the fork tip indicates the anterior border of the tibial implant.

Apply counter pressure by hand or using the Hex Driver as necessary to disengage the tibial plate from the detent feature.

**Note:** Do not impact the assembly. This action may result in damage to the tibia component, instrumentation and/or the bone.

## DETAILED OPERATIVE TECHNIQUE

### PREPARE AND IMPLANT THE TIBIAL PLATE

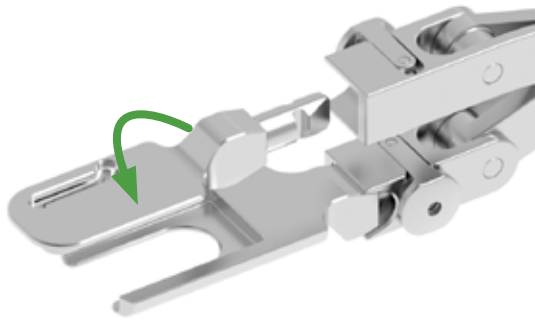

**Figure 74**  
Reverse Tibial Inserter Tip

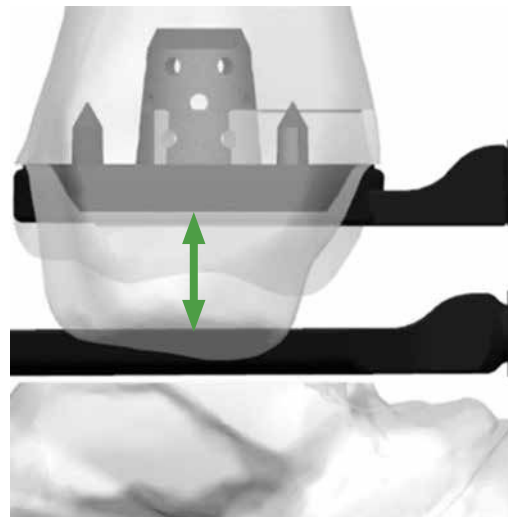

**Figure 75**  
Reattach Inserter to Implant

If a window opening was created, return the excised bone to fill the window void prior to impaction, along with any additional autograft material as desired by the user.

The user may optionally use the distraction assembly to apply parallel distraction during final impaction. In this case, reverse the **Tibial Implant Inserter Tip** (Figure 74), and follow the steps in the subsequent figures.

Alternatively, the user may insert the **Tibial Protector** now and skip ahead to Figure 76 to begin impacting the tibial plate without using the distraction assembly.

Allow the tibial implant to partially enter the prepared holes. Reset the Modular Distractor to the closed position. Reattach the tibial implant to the Tibial Implant Inserter Tip, this time with the Fork Distractor contacting the talus. Spread the joint distractor such that even pressure is applied to the tibial implant in the axial plane (Figure 75).

 An optional lateral fluoroscopic image may be taken at this point to ensure the tibial plate is entering the distal tibia orthogonal to the cut surface.

 Signifies fluoroscopic image



**Figure 76**  
Impact Tibial Plate



**Figure 77**  
Remove Tibial Instrumentation

---

Attach the Tibial Impactor Tip to the Modular Punch Arm. Align to the center of the tibial implant and begin impacting until the device sits flush with the distal tibial cortex. Throughout this step, continue spreading the joint wider to maintain a constant even pressure for tibial implant insertion (*Figure 76*).

Remove the impaction and spreader assemblies. Apply counter pressure to the tibial component to disengage the locking mechanism (*Figure 77*).

Insert the Tibial Protector.

## DETAILED OPERATIVE TECHNIQUE

### IMPLANT TALAR COMPONENT AND LINER



**Figure 78**  
Impact Talus

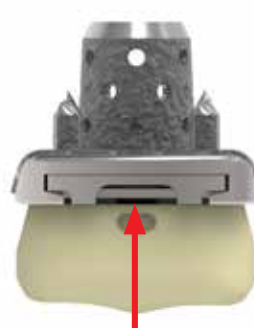

Locking Clip Not Engaged

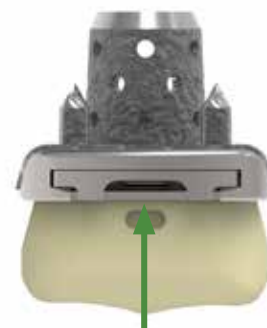

Locking Clip Engaged

**Figure 79**  
Insert Liner and Locking Clip

### IMPLANT TALAR COMPONENT AND LINER

Refer to OPTECH-000177 for proper assembly/disassembly instructions for the **Talar Impactor Cover** and **Talar Impactor Frame**. Incorrect assembly/disassembly of these components could cause premature damage to the devices. Attach the Talar Impactor Cover to the Talar Impactor Frame and then to the Modular Impactor Handle. Insert the talar implant and begin impacting the proximal surface. Plantarflexing the foot may assist with insertion/impaction. Ensure the component is fully seated onto the bone (*Figure 78*).

Remove the tibial protector and insert the **Tibial Liner Trial** to verify the proper liner thickness for proper ligament tensioning. Take care not to scratch the polished talar surface when the tibial protector is removed. Insert the corresponding Activit-E Tibial Insert of the same size and thickness as the verified liner trial into the T-slot of the tibial component by hand until resistance is met. Either manually push the liner posteriorly, or align the tip of the **Activit-E Liner Inserter Handle** with the recess on the anterior face of the insert (*Figure 78*), and grasp the handle to carefully apply force posteriorly until the hump of the talus is overcome.

**Note:** Do not impact the Activit-E Tibial Liner Inserter Handle as this action may result in damage to the tibial liner, the liner inserter handle, and/or the bone.

Insert the tibial locking clip (*Figure 79*).

**Note:** The locking clip is based on the tibial size, and the polyethylene size is determined by the talar component.

The entire wound is irrigated with antibiotic solution and a closed suction drainage system is placed. The deep tissue and extensor retinaculum are closed in an interrupted fashion. The subcutaneous tissue is closed. Skin edges are approximated with an interrupted skin closure. A sterile compression dressing and short-leg cast are applied with the ankle in neutral position.

**Note:** The AP Sizer Drill, Corner Drill, Peripheral Peg Punch, saw blades, pins/ screws, and all Vantage implants are single-use only. After use/explantation, they should be considered as biohazardous materials and disposed of following applicable local regulations and surgical center controls for disposal of biohazardous waste.

## INSTRUMENT LISTING

### CATALOG NUMBER DESCRIPTION

03-CNB-5G-0000\* Vantage 3D/3D+ Curved/Flat Cut Gap Check Tool, Sz 5



03-CNB-AP-0000 Vantage Ankle 3D/3D+ AP Size Indicator



03-CNB-AR-0000 Vantage Ankle 3D/3D+ Alignment Rod



03-CNB-AW-0000 Vantage Ankle 3D/3D+ Reversible Angel Wing

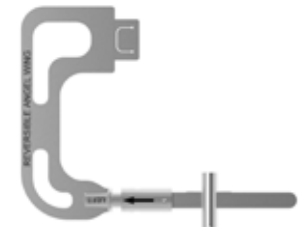

03-CNB-CC-0000 Vantage Ankle 3D/3D+ Corner Chisel



03-CNB-CD-0001 Vantage Ankle 3D/3D+ Corner Drill, ZH Connection



03-CNB-CP-0000 Vantage Ankle 3D/3D+ Corner Plug



03-CNB-DG-0000 Vantage Ankle 3D/3D+ AP Sizing Drill Guide



03-CNB-DR-0001 Vantage Ankle 3D/3D+ AP Sizing Drill, ZH Connection



03-CNB-FG-0000 Vantage Ankle 3D/3D+ Flat Cut Gap Check Tool



03-CNB-LN-0000 Activit-E Tibial Liner Inserter Handle



03-CNB-MA-0000 Vantage Ankle 3D/3D+ Modular Impactor Arm, Offset Strikeplate



03-CNB-MP-0000 Vantage Ankle 3D/3D+ Tibial Plate Impactor



## INSTRUMENT LISTING

### CATALOG NUMBER DESCRIPTION

03-CNB-RP-0000 Vantage Ankle 3D /3D+ Cruciform Punch



03-PNB-AW-0102 Vantage Ankle 3D+ Anterior Window Cut Block - Sizes 1-2

03-PNB-AW-0003 - Vantage Ankle 3D+ Anterior Window Cut Block - Size 3

03-PNB-AW-0004 Vantage Ankle 3D+ Anterior Window Cut Block - Size 4

03-PNB-AW-0005 Vantage Ankle 3D+ Anterior Window Cut Block - Size 5

03-PNB-AW-0006 Vantage Ankle 3D+ Anterior Window Cut Block - Size 6

03-PNB-CB-0102 Vantage Ankle 3D/3D+ Tibial Cut Block - Sizes 1&2

03-PNB-CB-0003 Vantage Ankle 3D/3D+ Tibial Cut Block - Size 3

03-PNB-CB-0004 Vantage Ankle 3D/3D+ Tibial Cut Block - Size 4

03-PNB-CB-0005 Vantage Ankle 3D/3D+ Tibial Cut Block - Size 5

03-PNB-CB-0006 Vantage Ankle 3D/3D+ Tibial Cut Block - Size 6



03-PNB-FT-0002 Vantage 3D+ Fork Distractor Tip – Size 1&2

03-PNB-FT-0003 Vantage 3D+ Fork Distractor Tip – Size 3

03-PNB-FT-0004 Vantage 3D+ Fork Distractor Tip – Size 4

03-PNB-FT-0005 Vantage 3D+ Fork Distractor Tip – Size 5

03-PNB-FT-0006 Vantage 3D+ Fork Distractor Tip – Size 6

03-PNB-MD-0000 Vantage 3D+ Modular Distractor

03-PNB-MT-0000 Vantage 3D+ Implant Inserter Tip

03-PNB-PG-0001 Vantage Ankle 3D/3D+ Tibial Punch Guide - Size 1

03-PNB-PG-0002 Vantage Ankle 3D/3D+ Tibial Punch Guide - Size 2

03-PNB-PG-0003 Vantage Ankle 3D/3D+ Tibial Punch Guide - Size 3

03-PNB-PG-0004 Vantage Ankle 3D/3D+ Tibial Punch Guide - Size 4

03-PNB-PG-0005 Vantage Ankle 3D/3D+ Tibial Punch Guide - Size 5

03-PNB-PG-0006 Vantage Ankle 3D/3D+ Tibial Punch Guide - Size 6



03-PNB-TP-0000 Vantage Ankle 3D+ Tall Cage Punch



PI-3695 Lamina Distractor



03-CNB-PP-0000 Vantage Ankle 3D/3D+ Peripheral Peg Punch



**CATALOG NUMBER DESCRIPTION**

03-CNB-RM-1508	Vantage Ankle 3D/3D+ Reamer - 15mm X 8mm
03-CNB-RM-1509	Vantage Ankle 3D/3D+ Reamer - 15mm X 9mm
03-CNB-RM-1510	Vantage Ankle 3D/3D+ Reamer - 15mm X 10mm
03-CNB-RM-1511	Vantage Ankle 3D/3D+ Reamer - 15mm X 11mm
03-CNB-RM-1512	Vantage Ankle 3D/3D+ Reamer - 15mm X 12mm
03-CNB-RM-1513	Vantage Ankle 3D/3D+ Reamer - 15mm X 13mm
03-CNB-RM-1514	Vantage Ankle 3D/3D+ Reamer - 15mm X 14mm
03-CNB-RM-1515	Vantage Ankle 3D/3D+ Reamer - 15mm X 15mm
03-PNB-RM-2010	Vantage Ankle 3D+ Reamer - 20mm X 10mm
03-PNB-RM-2011	Vantage Ankle 3D+ Reamer - 20mm X 11mm
03-PNB-RM-2012	Vantage Ankle 3D+ Reamer - 20mm X 12mm
03-PNB-RM-2013	Vantage Ankle 3D+ Reamer - 20mm X 13mm
03-PNB-RM-2014	Vantage Ankle 3D+ Reamer - 20mm X 14mm
03-PNB-RM-2015	Vantage Ankle 3D+ Reamer - 20mm X 15mm
03-PNB-RM-2510	Vantage Ankle 3D/3D+ Reamer - 25mm X 10mm
03-PNB-RM-2511	Vantage Ankle 3D/3D+ Reamer - 25mm X 11mm
03-PNB-RM-2512	Vantage Ankle 3D/3D+ Reamer - 25mm X 12mm
03-PNB-RM-2513	Vantage Ankle 3D/3D+ Reamer - 25mm X 13mm
03-PNB-RM-2514	Vantage Ankle 3D/3D+ Reamer - 25mm X 14mm
03-PNB-RM-2515	Vantage Ankle 3D/3D+ Reamer - 25mm X 15mm
03-PNB-RM-3010	Vantage Ankle 3D/3D+ Reamer - 30mm X 10mm
03-PNB-RM-3011	Vantage Ankle 3D/3D+ Reamer - 30mm X 11mm
03-PNB-RM-3012	Vantage Ankle 3D/3D+ Reamer - 30mm X 12mm
03-PNB-RM-3013	Vantage Ankle 3D/3D+ Reamer - 30mm X 13mm
03-PNB-RM-3014	Vantage Ankle 3D/3D+ Reamer - 30mm X 14mm
03-PNB-RM-3015	Vantage Ankle 3D/3D+ Reamer - 30mm X 15mm
03-PNB-WC-1501	Vantage 3D+ Window Checker - 15mm Stem - Small
03-PNB-WC-2001	Vantage 3D+ Window Checker - 20mm Stem - Small
03-PNB-WC-2501	Vantage 3D+ Window Checker - 25mm Stem - Small
03-PNB-WC-2502	Vantage 3D+ Window Checker - 25mm Stem - Large
03-PNB-WC-3001	Vantage 3D+ Window Checker - 30mm Stem - Small
03-PNB-WC-3002	Vantage 3D+ Window Checker - 30mm Stem - Large
03-PNB-AW-0102	Vantage Ankle 3D+ Anterior Window Cut Block - Sizes 1-2
03-PNB-AW-0003	Vantage Ankle 3D+ Anterior Window Cut Block - Size 3
03-PNB-AW-0004	Vantage Ankle 3D+ Anterior Window Cut Block - Size 4
03-PNB-AW-0005	Vantage Ankle 3D+ Anterior Window Cut Block - Size 5
03-PNB-AW-0006	Vantage Ankle 3D+ Anterior Window Cut Block - Size 6
351-00-06	Adjustable Talar Cut Block - Sizes 2-12mm



## INSTRUMENT LISTING

### CATALOG NUMBER DESCRIPTION

351-01-10 Scissor Style Inserter Handle



351-05-00 Talus Drill



351-07-03 Low-Profile Talar Impactor Frame



351-07-04 Low-Profile Talar Impactor Cover



351-10-00 Tibial Alignment Guide



351-10-12 Medial Shim



351-10-32 Posterior Capsule Removal Tool



351-10-34 Tibial Bone Removal Screw



351-17-01 Tibial Plate Protector

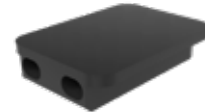

03-CNB-PL-1206 Vantage Ankle 3D/3D+ Punch Liner, Size 1-2, 6mm

03-CNB-PL-1208 Vantage Ankle 3D/3D+ Punch Liner, Size 1-2, 8mm

03-CNB-PL-1210 Vantage Ankle 3D/3D+ Punch Liner, Size 1-2, 10mm

03-CNB-PL-1212 Vantage Ankle 3D/3D+ Punch Liner, Size 1-2, 12mm

03-CNB-PL-1214 Vantage Ankle 3D/3D+ Punch Liner, Size 1-2, 14mm

03-CNB-PL-1216 Vantage Ankle 3D/3D+ Punch Liner, Size 1-2, 16mm

03-CNB-PL-1218 Vantage Ankle 3D/3D+ Punch Liner, Size 1-2, 18mm

03-CNB-PL-3506 Vantage Ankle 3D/3D+ Punch Liner, Sizes 3-5, 6mm

03-CNB-PL-3508 Vantage Ankle 3D/3D+ Punch Liner, Sizes 3-5, 8mm

03-CNB-PL-3510 Vantage Ankle 3D/3D+ Punch Liner, Sizes 3-5, 10mm

03-CNB-PL-3512 Vantage Ankle 3D/3D+ Punch Liner, Sizes 3-5, 12mm

03-CNB-PL-3514 Vantage Ankle 3D/3D+ Punch Liner, Sizes 3-5, 14mm

03-CNB-PL-3516 Vantage Ankle 3D/3D+ Punch Liner, Sizes 3-5, 16mm

03-CNB-PL-3518 Vantage Ankle 3D/3D+ Punch Liner, Sizes 3-5, 18mm



351-23-01 Activit-E Fixed Bearing Liner Trial – Size 1 – Left - 6mm

351-23-02 Activit-E Fixed Bearing Liner Trial – Size 2 – Left - 6mm

351-23-03 Activit-E Fixed Bearing Liner Trial – Size 3 – Left - 6mm

351-23-04 Activit-E Fixed Bearing Liner Trial – Size 4 – Left - 6mm

351-23-05\* Activit-E Fixed Bearing Liner Trial – Size 5 – Left - 6mm



CATALOG NUMBER	DESCRIPTION
351-23-11	Activit-E Fixed Bearing Liner Trial – Size 1 – Left - 7mm
351-23-12	Activit-E Fixed Bearing Liner Trial – Size 2 – Left - 7mm
351-23-13	Activit-E Fixed Bearing Liner Trial – Size 3 – Left - 7mm
351-23-14	Activit-E Fixed Bearing Liner Trial – Size 4 – Left - 7mm
351-23-15*	Activit-E Fixed Bearing Liner Trial – Size 5 – Left - 7mm
351-23-21	Activit-E Fixed Bearing Liner Trial – Size 1 – Left - 8mm
351-23-22	Activit-E Fixed Bearing Liner Trial – Size 2 – Left - 8mm
351-23-23	Activit-E Fixed Bearing Liner Trial – Size 3 – Left - 8mm
351-23-24	Activit-E Fixed Bearing Liner Trial – Size 4 – Left - 8mm
351-23-25*	Activit-E Fixed Bearing Liner Trial – Size 5 – Left - 8mm
351-23-31*	Activit-E Fixed Bearing Liner Trial – Size 1 – Left - 9mm
351-23-32*	Activit-E Fixed Bearing Liner Trial – Size 2 – Left - 9mm
351-23-33*	Activit-E Fixed Bearing Liner Trial – Size 3 – Left - 9mm
351-23-34*	Activit-E Fixed Bearing Liner Trial – Size 4 – Left - 9mm
351-23-35*	Activit-E Fixed Bearing Liner Trial – Size 5 – Left - 9mm
351-23-41	Activit-E Fixed Bearing Liner Trial – Size 1 – Left - 10mm
351-23-42	Activit-E Fixed Bearing Liner Trial – Size 2 – Left - 10mm
351-23-43	Activit-E Fixed Bearing Liner Trial – Size 3 – Left - 10mm
351-23-44	Activit-E Fixed Bearing Liner Trial – Size 4 – Left - 10mm
351-23-45*	Activit-E Fixed Bearing Liner Trial – Size 5 – Left - 10mm
351-23-51*	Activit-E Fixed Bearing Liner Trial – Size 1 – Left - 11mm
351-23-52*	Activit-E Fixed Bearing Liner Trial – Size 2 – Left - 11mm
351-23-53*	Activit-E Fixed Bearing Liner Trial – Size 3 – Left - 11mm
351-23-54*	Activit-E Fixed Bearing Liner Trial – Size 4 – Left - 11mm
351-23-55*	Activit-E Fixed Bearing Liner Trial – Size 5 – Left - 11mm
351-23-61	Activit-E Fixed Bearing Liner Trial – Size 1 – Left - 12mm
351-23-62	Activit-E Fixed Bearing Liner Trial – Size 2 – Left - 12mm
351-23-63	Activit-E Fixed Bearing Liner Trial – Size 3 – Left - 12mm
351-23-64	Activit-E Fixed Bearing Liner Trial – Size 4 – Left - 12mm
351-23-65*	Activit-E Fixed Bearing Liner Trial – Size 5 – Left - 12mm
351-23-71	Activit-E Fixed Bearing Liner Trial - Size 1 - Left - 14mm
351-23-72	Activit-E Fixed Bearing Liner Trial - Size 2 - Left - 14mm
351-23-73	Activit-E Fixed Bearing Liner Trial - Size 3 - Left - 14mm
351-23-74	Activit-E Fixed Bearing Liner Trial - Size 4 - Left - 14mm
351-23-75*	Activit-E Fixed Bearing Liner Trial - Size 5 - Left - 14mm
351-23-81	Activit-E Fixed Bearing Liner Trial - Size 1 - Left - 16mm
351-23-82	Activit-E Fixed Bearing Liner Trial - Size 2 - Left - 16mm
351-23-83	Activit-E Fixed Bearing Liner Trial - Size 3 - Left - 16mm
351-23-84	Activit-E Fixed Bearing Liner Trial - Size 4 - Left - 16mm
351-23-85*	Activit-E Fixed Bearing Liner Trial - Size 5 - Left - 16mm
351-23-91	Activit-E Fixed Bearing Liner Trial - Size 1 - Left - 18mm
351-23-92	Activit-E Fixed Bearing Liner Trial - Size 2 - Left - 18mm
351-23-93	Activit-E Fixed Bearing Liner Trial - Size 3 - Left - 18mm
351-23-94	Activit-E Fixed Bearing Liner Trial - Size 4 - Left - 18mm
351-23-95*	Activit-E Fixed Bearing Liner Trial - Size 5 - Left - 18mm

## INSTRUMENT LISTING

### CATALOG NUMBER DESCRIPTION

351-24-01	Activit-E Fixed Bearing Liner Trial – Size 1 – Right – 6mm
351-24-02	Activit-E Fixed Bearing Liner Trial – Size 2 – Right – 6mm
351-24-03	Activit-E Fixed Bearing Liner Trial – Size 3 – Right – 6mm
351-24-04	Activit-E Fixed Bearing Liner Trial – Size 4 – Right – 6mm
351-24-05*	Activit-E Fixed Bearing Liner Trial – Size 5 – Right – 6mm
351-24-11	Activit-E Fixed Bearing Liner Trial – Size 1 – Right – 7mm
351-24-12	Activit-E Fixed Bearing Liner Trial – Size 2 – Right – 7mm
351-24-13	Activit-E Fixed Bearing Liner Trial – Size 3 – Right – 7mm
351-24-14	Activit-E Fixed Bearing Liner Trial – Size 4 – Right – 7mm
351-24-15*	Activit-E Fixed Bearing Liner Trial – Size 5 – Right – 7mm
351-24-21	Activit-E Fixed Bearing Liner Trial – Size 1 – Right – 8mm
351-24-22	Activit-E Fixed Bearing Liner Trial – Size 2 – Right – 8mm
351-24-23	Activit-E Fixed Bearing Liner Trial – Size 3 – Right – 8mm
351-24-24	Activit-E Fixed Bearing Liner Trial – Size 4 – Right – 8mm
351-24-25*	Activit-E Fixed Bearing Liner Trial – Size 5 – Right – 8mm
351-24-31*	Activit-E Fixed Bearing Liner Trial – Size 1 – Right – 9mm
351-24-32*	Activit-E Fixed Bearing Liner Trial – Size 2 – Right – 9mm
351-24-33*	Activit-E Fixed Bearing Liner Trial – Size 3 – Right – 9mm
351-24-34*	Activit-E Fixed Bearing Liner Trial – Size 4 – Right – 9mm
351-24-35*	Activit-E Fixed Bearing Liner Trial – Size 5 – Right – 9mm
351-24-41	Activit-E Fixed Bearing Liner Trial – Size 1 – Right – 10mm
351-24-42	Activit-E Fixed Bearing Liner Trial – Size 2 – Right – 10mm
351-24-43	Activit-E Fixed Bearing Liner Trial – Size 3 – Right – 10mm
351-24-44	Activit-E Fixed Bearing Liner Trial – Size 4 – Right – 10mm
351-24-45*	Activit-E Fixed Bearing Liner Trial – Size 5 – Right – 10mm
351-24-51*	Activit-E Fixed Bearing Liner Trial – Size 1 – Right – 11mm
351-24-52*	Activit-E Fixed Bearing Liner Trial – Size 2 – Right – 11mm
351-24-53*	Activit-E Fixed Bearing Liner Trial – Size 3 – Right – 11mm
351-24-54*	Activit-E Fixed Bearing Liner Trial – Size 4 – Right – 11mm
351-24-55*	Activit-E Fixed Bearing Liner Trial – Size 5 – Right – 11mm
351-24-61	Activit-E Fixed Bearing Liner Trial – Size 1 – Right – 12mm
351-24-62	Activit-E Fixed Bearing Liner Trial – Size 2 – Right – 12mm
351-24-63	Activit-E Fixed Bearing Liner Trial – Size 3 – Right – 12mm
351-24-64	Activit-E Fixed Bearing Liner Trial – Size 4 – Right – 12mm
351-24-65*	Activit-E Fixed Bearing Liner Trial – Size 5 – Right – 12mm
351-24-71	Activit-E Fixed Bearing Liner Trial - Size 1 - Right - 14mm
351-24-72	Activit-E Fixed Bearing Liner Trial - Size 2 - Right - 14mm
351-24-73	Activit-E Fixed Bearing Liner Trial - Size 3 - Right - 14mm
351-24-74	Activit-E Fixed Bearing Liner Trial - Size 4 - Right - 14mm
351-24-75*	Activit-E Fixed Bearing Liner Trial - Size 5 - Right - 14mm
351-24-81	Activit-E Fixed Bearing Liner Trial - Size 1 - Right - 16mm
351-24-82	Activit-E Fixed Bearing Liner Trial - Size 2 - Right - 16mm
351-24-83	Activit-E Fixed Bearing Liner Trial - Size 3 - Right - 16mm
351-24-84	Activit-E Fixed Bearing Liner Trial - Size 4 - Right - 16mm
351-24-85*	Activit-E Fixed Bearing Liner Trial - Size 5 - Right - 16mm



## INSTRUMENT LISTING

### CATALOG NUMBER DESCRIPTION

351-24-91 Activit-E Fixed Bearing Liner Trial - Size 1 - Right - 18mm  
 351-24-92 Activit-E Fixed Bearing Liner Trial - Size 2 - Right - 18mm  
 351-24-93 Activit-E Fixed Bearing Liner Trial - Size 3 - Right - 18mm  
 351-24-94 Activit-E Fixed Bearing Liner Trial - Size 4 - Right - 18mm  
 351-24-95\* Activit-E Fixed Bearing Liner Trial - Size 5 - Right - 18mm

351-90-00 Tibial Tubercle Pin



351-90-01 2.4mm x 3.5" Fluted Drill Bit

351-90-02 2.4mm x 2.5" Fluted Drill Bit

351-90-03 2.4mm x 3.5" Olive Pin



351-90-04 Talar Trial Screw

351-90-05 2.4mm x 3.5" Threaded Pin

351-90-06 2.4mm x 3.5" Threaded Olive Pin



351-90-07 Long Talar Trial Screw



351-90-20 Tubercle Pin Pouch

351-90-21 3.5" Pin Pouch

351-03-11 Flat Cut Trial - Size 1 - Left

351-03-12 Flat Cut Trial - Size 2 - Left

351-03-13 Flat Cut Trial - Size 3 - Left

351-03-14 Flat Cut Trial - Size 4 - Left

351-03-15\* Flat Cut Trial - Size 5 - Left

351-04-11 Flat Cut Trial - Size 1 - Right

351-04-12 Flat Cut Trial - Size 2 - Right

351-04-13 Flat Cut Trial - Size 3 - Right

351-04-14 Flat Cut Trial - Size 4 - Right

351-04-15\* Flat Cut Trial - Size 5 - Right



351-06-00 Flat Cut Coring Drill



351-10-16 Ankle Tensor Assembly



351-17-03 Ankle Tibial Inserter



351-90-22 2.5" Pin Pouch

351-90-24 Talar Trial Screw Pouch

351-91-03 Reciprocating Sawblade 8x50x1mm

## INSTRUMENT LISTING

### CATALOG NUMBER DESCRIPTION

351-91-04 Saw-10x75x1.19-Stryker  
 351-91-05 Saw-10x75x1.19-Hall  
 351-91-06 Ankle Reciprocating Saw - Hall

351-93-01 Ankle Impactor Handle



351-93-02 1/8" Hex Drive



351-99-12 Vantage Core Punch Liner Caddy Insert

351-99-13 Vantage Core A Base Tray

351-99-14 Vantage Core A Upper Insert

351-99-15 Vantage Core B+ Base Tray

351-99-21 Vantage GPS Caddy Insert

351-99-17 Vantage 3D+ Base Tray

351-99-19 Vantage 3D+ Upper Insert

351-99-18 Vantage 3D+ Tall Stem Tray

351-99-22 Tray Lid

## IMPLANT LISTING

03-CMB-LC-0102 Vantage Ankle 3D/3D+ Tibial Locking Clip - Sizes 1 & 2

03-CMB-LC-0003 Vantage Ankle 3D/3D+ Tibial Locking Clip - Size 3

03-CMB-LC-0004 Vantage Ankle 3D/3D+ Tibial Locking Clip - Size 4

03-CMB-LC-0005 Vantage Ankle 3D/3D+ Tibial Locking Clip - Size 5

03-CMB-LC-0006 Vantage Ankle 3D/3D+ Tibial Locking Clip - Size 6



03-PMR-10-0001\* Vantage FB 3D+ Tibial Plate, Right, 10mm Tall, Size 1

03-PMR-10-0002\* Vantage FB 3D+ Tibial Plate, Right, 10mm Tall, Size 2

03-PMR-10-0003\* Vantage FB 3D+ Tibial Plate, Right, 10mm Tall, Size 3

03-PMR-10-0004\* Vantage FB 3D+ Tibial Plate, Right, 10mm Tall, Size 4

03-PMR-10-0005\* Vantage FB 3D+ Tibial Plate, Right, 10mm Tall, Size 5

03-PMR-10-0006\* Vantage FB 3D+ Tibial Plate, Right, 10mm Tall, Size 6

03-PMR-15-0001 Vantage FB 3D+ Tibial Plate, Right, 15mm Tall, Size 1

03-PMR-15-0002 Vantage FB 3D+ Tibial Plate, Right, 15mm Tall, Size 2

03-PMR-15-0003 Vantage FB 3D+ Tibial Plate, Right, 15mm Tall, Size 3

03-PMR-15-0004 Vantage FB 3D+ Tibial Plate, Right, 15mm Tall, Size 4

03-PMR-15-0005 Vantage FB 3D+ Tibial Plate, Right, 15mm Tall, Size 5

03-PMR-15-0006 Vantage FB 3D+ Tibial Plate, Right, 15mm Tall, Size 6

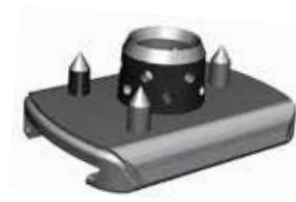

CATALOG NUMBER	DESCRIPTION
03-PMR-20-0001	Vantage FB 3D+ Tibial Plate, Right, 20mm Tall, Size 1
03-PMR-20-0002	Vantage FB 3D+ Tibial Plate, Right, 20mm Tall, Size 2
03-PMR-20-0003	Vantage FB 3D+ Tibial Plate, Right, 20mm Tall, Size 3
03-PMR-20-0004	Vantage FB 3D+ Tibial Plate, Right, 20mm Tall, Size 4
03-PMR-20-0005	Vantage FB 3D+ Tibial Plate, Right, 20mm Tall, Size 5
03-PMR-20-0006	Vantage FB 3D+ Tibial Plate, Right, 20mm Tall, Size 6
03-PMR-25-0001*	Vantage FB 3D+ Tibial Plate, Right, 25mm Tall, Size 1
03-PMR-25-0002*	Vantage FB 3D+ Tibial Plate, Right, 25mm Tall, Size 2
03-PMR-25-0003*	Vantage FB 3D+ Tibial Plate, Right, 25mm Tall, Size 3
03-PMR-25-0004*	Vantage FB 3D+ Tibial Plate, Right, 25mm Tall, Size 4
03-PMR-25-0005*	Vantage FB 3D+ Tibial Plate, Right, 25mm Tall, Size 5
03-PMR-25-0006*	Vantage FB 3D+ Tibial Plate, Right, 25mm Tall, Size 6
03-PMR-30-0001*	Vantage FB 3D+ Tibial Plate, Right, 30mm Tall, Size 1
03-PMR-30-0002*	Vantage FB 3D+ Tibial Plate, Right, 30mm Tall, Size 2
03-PMR-30-0003*	Vantage FB 3D+ Tibial Plate, Right, 30mm Tall, Size 3
03-PMR-30-0004*	Vantage FB 3D+ Tibial Plate, Right, 30mm Tall, Size 4
03-PMR-30-0005*	Vantage FB 3D+ Tibial Plate, Right, 30mm Tall, Size 5
03-PMR-30-0006*	Vantage FB 3D+ Tibial Plate, Right, 30mm Tall, Size 6
03-PML-10-0001*	Vantage FB 3D+ Tibial Plate, Left, 10mm Tall, Size 1
03-PML-10-0002*	Vantage FB 3D+ Tibial Plate, Left, 10mm Tall, Size 2
03-PML-10-0003*	Vantage FB 3D+ Tibial Plate, Left, 10mm Tall, Size 3
03-PML-10-0004*	Vantage FB 3D+ Tibial Plate, Left, 10mm Tall, Size 4
03-PML-10-0005*	Vantage FB 3D+ Tibial Plate, Left, 10mm Tall, Size 5
03-PML-10-0006*	Vantage FB 3D+ Tibial Plate, Left, 10mm Tall, Size 6
03-PML-15-0001	Vantage FB 3D+ Tibial Plate, Left, 15mm Tall, Size 1
03-PML-15-0002	Vantage FB 3D+ Tibial Plate, Left, 15mm Tall, Size 2
03-PML-15-0003	Vantage FB 3D+ Tibial Plate, Left, 15mm Tall, Size 3
03-PML-15-0004	Vantage FB 3D+ Tibial Plate, Left, 15mm Tall, Size 4
03-PML-15-0005	Vantage FB 3D+ Tibial Plate, Left, 15mm Tall, Size 5
03-PML-15-0006	Vantage FB 3D+ Tibial Plate, Left, 15mm Tall, Size 6
03-PML-20-0001	Vantage FB 3D+ Tibial Plate, Left, 20mm Tall, Size 1
03-PML-20-0002	Vantage FB 3D+ Tibial Plate, Left, 20mm Tall, Size 2
03-PML-20-0003	Vantage FB 3D+ Tibial Plate, Left, 20mm Tall, Size 3
03-PML-20-0004	Vantage FB 3D+ Tibial Plate, Left, 20mm Tall, Size 4
03-PML-20-0005	Vantage FB 3D+ Tibial Plate, Left, 20mm Tall, Size 5
03-PML-20-0006	Vantage FB 3D+ Tibial Plate, Left, 20mm Tall, Size 6
03-PML-25-0001*	Vantage FB 3D+ Tibial Plate, Left, 25mm Tall, Size 1
03-PML-25-0002*	Vantage FB 3D+ Tibial Plate, Left, 25mm Tall, Size 2
03-PML-25-0003*	Vantage FB 3D+ Tibial Plate, Left, 25mm Tall, Size 3
03-PML-25-0004*	Vantage FB 3D+ Tibial Plate, Left, 25mm Tall, Size 4
03-PML-25-0005*	Vantage FB 3D+ Tibial Plate, Left, 25mm Tall, Size 5
03-PML-25-0006*	Vantage FB 3D+ Tibial Plate, Left, 25mm Tall, Size 6

## IMPLANT LISTING

### CATALOG NUMBER DESCRIPTION

03-PML-30-0001*	Vantage FB 3D+ Tibial Plate, Left, 30mm Tall, Size 1
03-PML-30-0002*	Vantage FB 3D+ Tibial Plate, Left, 30mm Tall, Size 2
03-PML-30-0003*	Vantage FB 3D+ Tibial Plate, Left, 30mm Tall, Size 3
03-PML-30-0004*	Vantage FB 3D+ Tibial Plate, Left, 30mm Tall, Size 4
03-PML-30-0005*	Vantage FB 3D+ Tibial Plate, Left, 30mm Tall, Size 5
03-PML-30-0006*	Vantage FB 3D+ Tibial Plate, Left, 30mm Tall, Size 6

350-03-01	Flat Cut Talus - Size 1 - Left
350-03-02	Flat Cut Talus - Size 2 - Left
350-03-03	Flat Cut Talus - Size 3 - Left
350-03-04	Flat Cut Talus - Size 4 - Left
350-03-05*	Flat Cut Talus - Size 5 - Left

350-04-01	Flat Cut Talus - Size 1 - Right
350-04-02	Flat Cut Talus - Size 2 - Right
350-04-03	Flat Cut Talus - Size 3 - Right
350-04-04	Flat Cut Talus - Size 4 - Right
350-04-05*	Flat Cut Talus - Size 5 - Right

350-23-01	Activit-E Fixed Bearing Tibial Insert - Left - Size 1 - 6mm
350-23-02	Activit-E Fixed Bearing Tibial Insert - Left - Size 2 - 6mm
350-23-03	Activit-E Fixed Bearing Tibial Insert - Left - Size 3 - 6mm
350-23-04	Activit-E Fixed Bearing Tibial Insert - Left - Size 4 - 6mm
350-23-05*	Activit-E Fixed Bearing Tibial Insert - Left - Size 5 - 6mm
350-23-11	Activit-E Fixed Bearing Tibial Insert - Left - Size 1 - 7mm
350-23-12	Activit-E Fixed Bearing Tibial Insert - Left - Size 2 - 7mm
350-23-13	Activit-E Fixed Bearing Tibial Insert - Left - Size 3 - 7mm
350-23-14	Activit-E Fixed Bearing Tibial Insert - Left - Size 4 - 7mm
350-23-15*	Activit-E Fixed Bearing Tibial Insert - Left - Size 5 - 7mm
350-23-21	Activit-E Fixed Bearing Tibial Insert - Left - Size 1 - 8mm
350-23-22	Activit-E Fixed Bearing Tibial Insert - Left - Size 2 - 8mm
350-23-23	Activit-E Fixed Bearing Tibial Insert - Left - Size 3 - 8mm
350-23-24	Activit-E Fixed Bearing Tibial Insert - Left - Size 4 - 8mm
350-23-25*	Activit-E Fixed Bearing Tibial Insert - Left - Size 5 - 8mm

350-23-31*	Activit-E Fixed Bearing Tibial Insert - Left - Size 1 - 9mm
350-23-32*	Activit-E Fixed Bearing Tibial Insert - Left - Size 2 - 9mm
350-23-33*	Activit-E Fixed Bearing Tibial Insert - Left - Size 3 - 9mm
350-23-34*	Activit-E Fixed Bearing Tibial Insert - Left - Size 4 - 9mm
350-23-35*	Activit-E Fixed Bearing Tibial Insert - Left - Size 5 - 9mm

350-23-41	Activit-E Fixed Bearing Tibial Insert - Left - Size 1 - 10mm
350-23-42	Activit-E Fixed Bearing Tibial Insert - Left - Size 2 - 10mm
350-23-43	Activit-E Fixed Bearing Tibial Insert - Left - Size 3 - 10mm
350-23-44	Activit-E Fixed Bearing Tibial Insert - Left - Size 4 - 10mm
350-23-45*	Activit-E Fixed Bearing Tibial Insert - Left - Size 5 - 10mm

350-23-51*	Activit-E Fixed Bearing Tibial Insert - Left - Size 1 - 11mm
350-23-52*	Activit-E Fixed Bearing Tibial Insert - Left - Size 2 - 11mm
350-23-53*	Activit-E Fixed Bearing Tibial Insert - Left - Size 3 - 11mm
350-23-54*	Activit-E Fixed Bearing Tibial Insert - Left - Size 4 - 11mm
350-23-55*	Activit-E Fixed Bearing Tibial Insert - Left - Size 5 - 11mm



CATALOG NUMBER	DESCRIPTION
350-23-61	Activit-E Fixed Bearing Tibial Insert - Left - Size 1 - 12mm
350-23-62	Activit-E Fixed Bearing Tibial Insert - Left - Size 2 - 12mm
350-23-63	Activit-E Fixed Bearing Tibial Insert - Left - Size 3 - 12mm
350-23-64	Activit-E Fixed Bearing Tibial Insert - Left - Size 4 - 12mm
350-23-65*	Activit-E Fixed Bearing Tibial Insert - Left - Size 5 - 12mm
350-23-71	Activit-E Fixed Bearing Tibial Insert - Left - Size 1 - 14mm
350-23-72	Activit-E Fixed Bearing Tibial Insert - Left - Size 2 - 14mm
350-23-73	Activit-E Fixed Bearing Tibial Insert - Left - Size 3 - 14mm
350-23-74	Activit-E Fixed Bearing Tibial Insert - Left - Size 4 - 14mm
350-23-75*	Activit-E Fixed Bearing Tibial Insert - Left - Size 5 - 14mm
350-23-81	Activit-E Fixed Bearing Tibial Insert - Left - Size 1 - 16mm
350-23-82	Activit-E Fixed Bearing Tibial Insert - Left - Size 2 - 16mm
350-23-83	Activit-E Fixed Bearing Tibial Insert - Left - Size 3 - 16mm
350-23-84	Activit-E Fixed Bearing Tibial Insert - Left - Size 4 - 16mm
350-23-85*	Activit-E Fixed Bearing Tibial Insert - Left - Size 5 - 16mm
350-23-91	Activit-E Fixed Bearing Tibial Insert - Left - Size 1 - 18mm
350-23-92	Activit-E Fixed Bearing Tibial Insert - Left - Size 2 - 18mm
350-23-93	Activit-E Fixed Bearing Tibial Insert - Left - Size 3 - 18mm
350-23-94	Activit-E Fixed Bearing Tibial Insert - Left - Size 4 - 18mm
350-23-95*	Activit-E Fixed Bearing Tibial Insert - Left - Size 5 - 18mm
350-24-01	Activit-E Fixed Bearing Tibial Insert - Right - Size 1 - 6mm
350-24-02	Activit-E Fixed Bearing Tibial Insert - Right - Size 2 - 6mm
350-24-03	Activit-E Fixed Bearing Tibial Insert - Right - Size 3 - 6mm
350-24-04	Activit-E Fixed Bearing Tibial Insert - Right - Size 4 - 6mm
350-24-05*	Activit-E Fixed Bearing Tibial Insert - Right - Size 5 - 6mm
350-24-11	Activit-E Fixed Bearing Tibial Insert - Right - Size 1 - 7mm
350-24-12	Activit-E Fixed Bearing Tibial Insert - Right - Size 2 - 7mm
350-24-13	Activit-E Fixed Bearing Tibial Insert - Right - Size 3 - 7mm
350-24-14	Activit-E Fixed Bearing Tibial Insert - Right - Size 4 - 7mm
350-24-15*	Activit-E Fixed Bearing Tibial Insert - Right - Size 5 - 7mm

## INSTRUMENT LISTING

CATALOG NUMBER	DESCRIPTION
350-24-21	Activit-E Fixed Bearing Tibial Insert - Right - Size 1 - 8mm
350-24-22	Activit-E Fixed Bearing Tibial Insert - Right - Size 2 - 8mm
350-24-23	Activit-E Fixed Bearing Tibial Insert - Right - Size 3 - 8mm
350-24-24	Activit-E Fixed Bearing Tibial Insert - Right - Size 4 - 8mm
350-24-25	Activit-E Fixed Bearing Tibial Insert - Right - Size 5 - 8mm
350-24-31*	Activit-E Fixed Bearing Tibial Insert - Right - Size 1 - 9mm
350-24-32*	Activit-E Fixed Bearing Tibial Insert - Right - Size 2 - 9mm
350-24-33*	Activit-E Fixed Bearing Tibial Insert - Right - Size 3 - 9mm
350-24-34*	Activit-E Fixed Bearing Tibial Insert - Right - Size 4 - 9mm
350-24-35*	Activit-E Fixed Bearing Tibial Insert - Right - Size 5 - 9mm
350-24-41	Activit-E Fixed Bearing Tibial Insert - Right - Size 1 - 10mm
350-24-42	Activit-E Fixed Bearing Tibial Insert - Right - Size 2 - 10mm
350-24-43	Activit-E Fixed Bearing Tibial Insert - Right - Size 3 - 10mm
350-24-44	Activit-E Fixed Bearing Tibial Insert - Right - Size 4 - 10mm
350-24-45*	Activit-E Fixed Bearing Tibial Insert - Right - Size 5 - 10mm
350-24-51*	Activit-E Fixed Bearing Tibial Insert - Right - Size 1 - 11mm
350-24-52*	Activit-E Fixed Bearing Tibial Insert - Right - Size 2 - 11mm
350-24-53*	Activit-E Fixed Bearing Tibial Insert - Right - Size 3 - 11mm
350-24-54*	Activit-E Fixed Bearing Tibial Insert - Right - Size 4 - 11mm
350-24-55*	Activit-E Fixed Bearing Tibial Insert - Right - Size 5 - 11mm
350-24-61	Activit-E Fixed Bearing Tibial Insert - Right - Size 1 - 12mm
350-24-62	Activit-E Fixed Bearing Tibial Insert - Right - Size 2 - 12mm
350-24-63	Activit-E Fixed Bearing Tibial Insert - Right - Size 3 - 12mm
350-24-64	Activit-E Fixed Bearing Tibial Insert - Right - Size 4 - 12mm
350-24-65*	Activit-E Fixed Bearing Tibial Insert - Right - Size 5 - 12mm
350-24-71	Activit-E Fixed Bearing Tibial Insert - Right - Size 1 - 14mm
350-24-72	Activit-E Fixed Bearing Tibial Insert - Right - Size 2 - 14mm
350-24-73	Activit-E Fixed Bearing Tibial Insert - Right - Size 3 - 14mm
350-24-74	Activit-E Fixed Bearing Tibial Insert - Right - Size 4 - 14mm
350-24-75*	Activit-E Fixed Bearing Tibial Insert - Right - Size 5 - 14mm
350-24-81	Activit-E Fixed Bearing Tibial Insert - Right - Size 1 - 16mm
350-24-82	Activit-E Fixed Bearing Tibial Insert - Right - Size 2 - 16mm
350-24-83	Activit-E Fixed Bearing Tibial Insert - Right - Size 3 - 16mm
350-24-84	Activit-E Fixed Bearing Tibial Insert - Right - Size 4 - 16mm
350-24-85*	Activit-E Fixed Bearing Tibial Insert - Right - Size 5 - 16mm
350-24-91	Activit-E Fixed Bearing Tibial Insert - Right - Size 1 - 18mm
350-24-92	Activit-E Fixed Bearing Tibial Insert - Right - Size 2 - 18mm
350-24-93	Activit-E Fixed Bearing Tibial Insert - Right - Size 3 - 18mm
350-24-94	Activit-E Fixed Bearing Tibial Insert - Right - Size 4 - 18mm
350-24-95*	Activit-E Fixed Bearing Tibial Insert - Right - Size 5 - 18mm









These products are manufactured by Exactech, Inc. and distributed by Advita Ortho, LLC.

For additional device information, refer to the manufacturer's Instructions for Use for information including, but not limited to, a device description, indications, contraindications, precautions and warnings. For further product information, please contact Customer Service, Advita Ortho, LLC 2320 NW 66th Court, Gainesville, Florida 32653-1630, USA. (833) 4-ADVITA.

Exactech, as the manufacturer of this device, does not practice medicine and is not responsible for recommending the appropriate surgical technique for use on a particular patient. Because this information does not purport to constitute any diagnostic or therapeutic statement with regard to any individual medical case, each patient must be examined and advised individually, and this document does not replace the need for such examination and/or advice in whole or in part. These guidelines are intended to be solely informational, and each surgeon must evaluate the appropriateness of these guidelines based on his or her personal medical training and experience. Prior to use of this system, the surgeon should refer to the product package insert for information including, but not limited to, comprehensive warnings, precautions, indications for use, contraindications and adverse effects.

The products discussed herein may be available under different trademarks in different countries. All copyrights, and pending and registered trademarks, are property of Advita Ortho, LLC. **This material is intended for the sole use and benefit of the Advita Ortho sales force and physicians; it is not intended for laypersons.** It should not be redistributed, duplicated or disclosed without the express written consent of Advita Ortho, LLC. ©2026 Advita Ortho, LLC. OPTECH-000173/B 012326



GLOBAL HEADQUARTERS  
2320 NW 66TH COURT  
GAINESVILLE, FL 32653-1630 USA  
(833) 4-ADVITA  
advita.com